

Form 8483  
August, 1918

# LIST OF PARTS



**SINGER\*\***  
**MACHINES**  
**Nos. 52-54 and 52-74**

---

**THE SINGER MANUFACTURING COMPANY**

From the library of: Diamond Needle Corp

## INSTRUCTIONS FOR OILING

---

To ensure easy running and prevent unnecessary wear of the parts which are in movable contact, the machine requires oiling and when in continuous use, "TYPE B" or "TYPE D" OIL, sold by Singer Sewing Machine Company, should be applied at least twice each day to all oil holes marked "OIL", as instructed in Form 19768.

"TYPE D" OIL should be used when an oil is desired which will produce a minimum of stain on fabrics, even after a long period of storage.

## INDEX

---

	PAGE
ACCESSORIES.....	14
CORDER.....	15
FEED ROLLS.....	19
FOOT LIFTER PARTS.....	17
IRON BASE.....	14
KNEE LIFTER PARTS.....	18
MACHINE No. 52-54.....	7
"    "    52-74.....	14
NUMERICAL LIST OF PARTS.....	23
OBSOLETE PARTS.....	22
PRESSER FEET.....	15
TAPE HOLDERS.....	16
THREAD UNWINDER PARTS.....	18
UNDER DRIVER.....	20

From the library of: Diamond Needle Corp

# INSTRUCTIONS FOR ORDERING

In ordering from this list, use ONLY the part NUMBER in the FIRST column.

The number stamped on a Sewing Machine part is in every case the number of the single part only.

Every combination of parts sent out as such has its specific number, which, although not stamped on the parts, must be used when ordering the combination.

Each number always indicates the SAME PART in whatever list it appears, or for whatever machine.

The letters after some of the numbers indicate the style of finish only, as follows:

- A. Hardened, Polished and Plated.
- B. Polished and Plated
- C. Hardened only.
- D. Polished only.
- E. Soft, not Polished.
- F. Hardened and Polished.
- G.
- H. Blued.
- J. Plated only.
- K. Hardened and Plated.
- L. Brass or Gilt.
- M. Oxidized.
- P. Japanned.

These letters MUST BE USED *when* they appear in the list, and AFTER the number *as* in the list.

In this series

- 1 to 1500 and 50001 to 51500 are Screw Numbers.
- 1501 to 1800 are Nut Numbers.
- 1801 to 2000 are Roller Numbers.
- 2001 to 50000 and 52001 and upward are numbers of Machine Parts.

The figures in the second column refer only to the plates, illustrating the parts, and are NOT TO BE USED in ordering.

Parts marked with an asterisk (\*) are furnished only when repairs are made at factory.

When ordering parts which differ as to GAUGE (the distance between seams) the GAUGE as well as the NUMBER MUST BE GIVEN on order.

## LIST OF PARTS COMPLETE FOR MACHINE NO. 52-54 FOUR NEEDLES, FOUR HOOKS

NO.	PLATE	NAME
*13789	—	Arm.....
4389	7445	" Dowel Pin.....
54897	7442	" Oil Cup.....
13862	7442	" " Tube with 29599, for oiling 13799 and 13804.....
13831	7442	Arm Oil Tube (left) with 49092, for oiling 13811.....
13832	7442	Arm Oil Tube (right) with 49092, for oiling 13813.....
13833	—	Arm Oil Tube Bracket.....
13834	7442	" " " " 13833 with 13831 and 13832.....
898D	7450	Arm Oil Tube Bracket Screw.....
29599	7442	" " " Packing (felt) for 13862..... per 100
49092	7442	Arm Oil Tube Packing (felt) for 13831 and 13832.....
880E	7450	Arm Screw (left).....
138E	7450	" " (right).....
13793	7440	" Shaft.....
13794	7440	" " Flanged Bushing (back).....
56006	7442	" " " " " Oil Pad (braided cotton).....
446c	2831	Arm Shaft Flanged Bushing (back) Set Screw.....
13795	7440	Arm Shaft Flanged Bushing (front).....
56006	7442	" " " " " Oil Pad (braided cotton).....
443c	7450	Arm Shaft Flanged Bushing (front) Set Screw.....
144D	7450	Arm Shaft Screw.....
15196	7441	" Side Cover.....
286D	7450	" " " Thumb Screw.....
13796	7441	Balance Wheel, 2 1/8 in. pulley, with two 448c.....
13797	7441	Balance Wheel Oil Cover.....
210D	7450	" " " " Screw.....
448c	7450	" " Set Screw.....

From the library of the Diamond Needle Co.

NO.	PLATE	NAME
*13798	—	Bed.....
13799	7441	Crank Connecting Rod with 13800 and two 145E.....
*13800	—	Crank Connecting Rod Cap.....
145E	7450	" " " " Screw.....
375c	7450	" " " " Hinge Screw.....
1518E	7450	" " " " " Nut
13849	7441	Face Plate.....
190D	7442	" " Screw.....
13802	7443	Feed Bar.....
315c	2642	" " Screw Centre.....
1519E	7450	" " " " Nut.....
2039	7444	" Connecting Link.....
378c	7444	" " " Hinge Screw (long)
380c	7444	" " " " " (short)
1520E	7444	" " " " " Nut.
48082	5387	" Dog.....
48083	5388	" ".....
48084	5389	" ".....
48085	5390	" ".....
48086	5391	" ".....
48089	5394	" ".....
48090	5395	" ".....
48091	5396	" ".....
48087	5392	" " for gathering.....
48088	5393	" " " ".....
191c	7450	" " Screw.....
13803	7444	" and Feed Lifting Eccentric with 448c.....
448c	7450	Feed and Feed Lifting Eccentric Set Screw.....
13804	7444	Feed and Feed Lifting Eccentric Sleeve..
13805	7440	" Forked Connection.....
378c	7444	" " " " Hinge Screw...
1520E	7444	" " " " " Nut
13806	7440	" Lifting Rock Shaft.....
13807	—	Feed Lifting Rock Shaft complete, Nos. 2509 and 13806.....
13808	7440	Feed Lifting Rock Shaft Connecting Rod with 43977 and two 145E.....
*43977	—	Feed Lifting Rock Shaft Connecting Rod Cap.....
145E	7450	Feed Lifting Rock Shaft Connecting Rod Cap Screw.....
375c	7450	Feed Lifting Rock Shaft Connecting Rod Hinge Screw.....

NO.	PLATE	NAME
1518E	7450	Feed Lifting Rock Shaft Connecting Rod Hinge Screw Nut.....
2509	7444	Feed Lifting Rock Shaft Crank with 157J and 1813.....
157J	7444	Feed Lifting Rock Shaft Crank Clamping Screw.....
1813	7444	Feed Lifting Rock Shaft Crank Roller and Stud.....
307c	7450	Feed Lifting Rock Shaft Screw Centre
1513J	2642	" " " " " " Nut.....
2164	7444	Feed Regulator.....
74E	7444	" " Hinge Screw.....
747D	7444	" " Thumb Screw.....
21350	7444	" " " " Stop.....
2017	7440	" Rock Shaft.....
2046	—	Feed Rock Shaft complete, Nos. 2047 and 2048.....
2048	7444	Feed Rock Shaft Crank with 465c.....
2049	7444	" " " " Pin.....
465c	7444	" " " " Set Screw.....
307c	7450	" " " " Screw Centre.....
1513J	2642	" " " " " Nut.....
13809	7445	Looper.....
13864	7459	" Carrier with two 237F and four 853c.....
237F	7450	Looper Carrier Set Screw.....
13516	7445	" " Shaft.....
13836	7445	" " " Bushing.....
448c	7450	" " " " Set Screw.
217F	7450	" " " " Set Screw.....
13811	7441	" Driving Shaft with 217F.....
13812	7445	" " " Crank with two 1253c.....
1253c	7445	Looper Driving Shaft Crank Set Screw..
13813	7445	" " " Link.....
13814	7445	" " " " Hinge Pin....
1253c	7445	" " " " " " Set Screw.....
853c	7450	Looper Set Screw.....
13581	7441	Needle Bar (hollow).....
13582	7444	" " Connecting Link with 794E..
794E	7444	" " " " Adjusting Screw.....
881c	7444	Needle Bar Connecting Link Hinge Screw
13896	7444	" " " Stud with 1904 and two 175E.....

NO.	PLATE	NAME
175E	7444	Needle Bar Connecting Stud Clamping Screw.....
1904	7444	Needle Bar Connecting Stud Roller (roller only).....
13816	7440	Needle Bar Crank with 435c and 1293c.....
1293c	7450	" " " Position Screw.....
435c	2831	" " " Set Screw.....
13558	7459	" Clamp with four 620F or 50014F, for $\frac{1}{8}$ in. to $\frac{1}{4}$ in. gauge.....
13863	7459	Needle Clamp with four 50014F, for $\frac{1}{8}$ in. gauge and above.....
2273	7445	Needle Clamp Pin.....
620F	7445	" Set Screw for 13558.....
50014F	7445	" " " " $\frac{9}{64}$ in. gauge and above.....
13818	7445	Oscillating Rock Shaft with 1253c.....
13819	7445	" " " Hinge Pin.....
13820	7445	" " " " " Bushing.....
448c	7450	" " " " " Set Screw.....
2058	7441	Presser Bar.....
52016	7445	" " Lifter.....
1058c	7445	" " " Hinge Screw.....
1520E	7444	" " " " " Nut.....
2953	7445	" " Lifting Bracket with 453c.....
453c	2831	" " " " Set Screw.....
3100	7445	" " Spring.....
2070	7445	" " Washer.....
30331	5486	" Foot, for braiding.....
31096	5494	" " " cording, with three cord tubes and guide for upper strip.....
30332	5487	Presser Foot, for gathering.....
30335	5490	" " " general work.....
31097	5486	" " " rims of soft hats.....
31101	5494	" " " strip cording, with guides for upper and under strips and three cord tubes.....
31083	3032	Presser Foot (hinged) for general work.....
31090	5492	" " " " lap seam feller, leaving out the first needle from the right hand side and the second needle from the left hand side.....
31092	5492	Presser Foot (hinged, adjustable) for gathering.....
30327	4655	Presser Foot (hinged, tube).....
30330	4655	" " " " for two strips.....

NO.	PLATE	NAME
31082	3031	Presser Foot (hinged tube) for two strips for reeding.....
30334	5489	Presser Foot (hinged, tube) leaving out the first needle from the right hand side.....
31100	5495	Presser Foot (side hinged) for general work.....
31084	3032	Presser Foot (double strip folding).....
31088	3091	" " (strip folding) for cloth work.....
31091	5491	Presser Foot (strip folding) for general work.....
31089	3092	Presser Foot (strip folding) for woolen shirts, for folding the front plait and stitching to the body of the shirt in one operation.....
31098	5445	Presser Foot (strip folding) with guide for interlining for woolen shirts for folding the front plait and stitching to the body of the shirt in one operation.....
31093	4627	Presser Foot (strip folding) with two cord tubes between the first and second needles from the right hand side and the first and second needles from the left hand side.....
31081	3031	Presser Foot (strip folding) with three cord tubes.....
30338	4681	Presser Foot (strip folding) with five cord tubes.....
30339	5491	Presser Foot (strip folding) with tube for cording, leaving out the first needle from the right hand side and the second needle from the left hand side.....
30340	4681	Presser Foot (strip folding and cording) for covering two cords with two folded strips.....
30337	5489	Presser Foot (tube).....
30326	5484	" " " for reeding, leaving out the first needle from the left hand side.....
31095	5493	Presser Foot (tube) for strip, lining and interlining, grooved on bottom for three steels.....
30328	5485	Presser Foot (tube) for two strips.....
31086	3033	" " " " " " ".....
31099	5485	" " " " " " " and under strip.....

NO.	PLATE	NAME
31094	5493	Presser Foot (tube) for two strips, for reeding.....
30333	5488	Presser Foot (tube) for two strips, for reeding between the first and second needles from the right hand side and the first and second needles from the left hand side.....
30329	5484	Presser Foot (tube) with two grooves on bottom for reeding.....
30336	5488	Presser Foot (tube) with three grooves on bottom for reeding.....
31085	3033	Presser Foot with keel, slotted for tape...
	190D 7442	" " Screw.....
	263E 7450	Pressure Regulating Thumb Screw.....
13887	7470	Tension Bracket with eight 13589.....
13888	—	Tension Bracket complete, Nos. 13887, four each 637c, 1547d, 1560c, 13710 and eight 2921.....
	898F 7450	Tension Bracket Screw.....
	2921 7442	" Disc.....
13589	7442	" " Steady Pin.....
	1560c 7442	" Regulating Thumb Nut.....
	637c 7442	" Screw Stud.....
	1547D 7442	" " " Nut.....
13710	7442	" Spring.....
13589	7442	" Thread Guide Pin.....
13850	—	Thread Guide (back of arm) four holes...
13851	7456	" " " " " 13850 with 13862.....
13852	7459	Thread Guide (side of arm) four holes...
	219D 7450	" " " " " Screw.....
13853	—	" " (top of arm) four holes...
13854	7457	" " " " " 13853 with 13862.....
50062J	7450	Thread Guide (top of arm) Screw.....
13844	7442	" Controller Post.....
	190D 7442	" " " Screw.....
13845	7442	" " Spring.....
	233D 7442	" " " Screw.....
13846	7442	" " Thread Guide.....
13847	—	Thread Controller complete, Nos. 233D, 13844 and 13845.....
13594	7445	Thread Take-up Plate.....
	883B 7445	" " " Screw.....
48102	5387	Throat Plate for 48082.....
48103	5388	" " " 48083.....
48104	5389	" " " 48084.....

NO.	PLATE	NAME
48105	5390	Throat Plate for 48085.....
48106	5391	" " " 48086.....
48107	5392	" " " 48087.....
48108	5393	" " " 48088.....
48109	5394	" " " 48089.....
48110	5395	" " " 48090.....
48111	5396	" " " 48091.....
	691F 7450	" " Screw.....
13635	1514	Drip Pan with four 1 in. wire nails.....

SINGER Needles should be used  
in SINGER Machines  
These Needles and their Containers  
are marked with the  
Company's Trade Mark "SIMANCO." 1

Needles in Containers marked  
"FOR SINGER MACHINES"  
are NOT SINGER made needles. 2

## MACHINE NO. 52-74

FOUR NEEDLES, FOUR HOOKS. MAKES FOUR TUCKS

This Machine is the same as 52-54 with Tuck Folding Attachment and the following exceptions:

NO.	PLATE	NAME
13835	7458	Face Plate (lower).....
13801	7458	" " (upper).....
190D	7442	" " " Screw.....
48462	5397	Feed Dog.....
48463	5398	" " .....
48464	5399	" " .....
48477	5496	Presser Foot (hinged).....
48497	5397	Throat Plate (thin stock) for 48462.....
48498	5398	" " " " " 48463.....
48499	5399	" " " " " 48464.....

NOTE: Tuck Folding Attachments can be furnished for machines in use, but machines must be returned to the factory to be fitted. When parts are required for repairs the sample must accompany the order.

## IRON BASE

NO.	PLATE	NAME
11118	7446	Bed Frame Cushion (leather).....
7263	7446	" " Hinge Connection (long).....
14098	7446	" " " " (short).....
14008	7446	" " " " Pin.....
970D	7446	" " Thumb Screw.....
13697	1511	" " with 970D, 2978, 7263, 14098, two 14008 and four each 11118 and wood screws 1¼ in. No. 12.....
2978	1514	Drip Pan.....

## ACCESSORIES

NO.	PLATE	NAME
12361	7446	Machine Hinge Connection.....
44139	7446	" " Plate.....
44140	—	Machine Hinge complete, Nos. 12361, 44139 and wood screw 1¼ in. No. 14..

NO.	PLATE	NAME
12405	7446	Machine Rest (felt).....
41400	7447	" " Pin (wood) 3¼ in. long...
36569	7447	Oiler with 36571.....
36570	—	" 36569, filled with oil.....
36571	7447	" Spout, 1¼ in. long, with 36807....
36807	7446	" " Washer (leather).....
26026	7447	Screw Driver (large).....
26485	7447	" " (small).....
35143	7447	Tweezers, 4 in.....
8909	7447	Wrench for 1513 and 1518.....
8908	7447	" " 1519 and 1520.....
4822	7447	" " 1521 and 1547.....

## CORDER

FOR MACHINE NO. 52-54

NO.	PLATE	NAME
28550	7453	Arm with Tip and Cord Guides.....
175D	7444	" Adjusting Screw.....
28554	7453	" Bracket.....
25790	7449	" Hinge Pin.....
28555	7453	Arm and Bracket complete, Nos. 175D, 25790, 28550 and 28551.....
26210	5483	Presser Foot.....
28561	—	Corder complete, Nos. 135D, 26210 and 28555.....
135D	7450	Corder Screw.....
26354	1512	Cord Guide Eyelet for 26356.....
26355	1512	" " Plate for 26356.....
26356	1512	Cord Guide (table) complete, Nos. 26355 and seven 26354.....
26358	1512	Cord Tension Pin for 26359.....
26357	1512	" " Plate for 26359.....
26359	1512	Cord Tension (bed) complete, Nos. 26357 and ten 26358.....

## PRESSER FEET

FOR MACHINE NO. 52-54

NO.	PLATE	NAME
28570	5483	Presser Foot, for continuous cording from the right or left.....
28571	5483	Presser Foot, for group cording.....





## KNEE LIFTER PARTS

NO.	PLATE	NAME
5596	7448	Bell Crank .....
5599	7448	" " Bracket .....
178E	7450	" " " Screw .....
5601	7446	" " Hinge Pin .....
5735	7446	" " Spring .....
5598	7448	Bell Crank complete, Nos. 5596, 5599, 5601 and 5735 .....
13587	7448	Lifting Lever .....
13588	7448	" " Connecting Rod .....
12416	7446	" " " " Joint .....
76D	7446	" " " " Hinge Screw .....
1521E	7446	Lifting Lever Connecting Rod Lock Nut
802D	7450	" " Hinge Screw .....
2763	1511	Rock Shaft .....
12242	1511	" " Hanger with two wood screws 1 in. No. 10 .....
2765	1511	Rock Shaft Knee Arm .....
2766	1511	" " " " Hub with 356c .....
356c	7450	" " " " " Set Screw .....
2768	—	Rock Shaft Knee Arm complete, Nos. 2765 to 2767 .....
2767	1511	Rock Shaft Knee Plate with 356c .....
356c	7450	" " " " " Set Screw .....
6337	1511	" " Lifting Bracket with two 356c
2778	1511	" " " " Hook .....
356c	7450	" " " " " S e t Screw .....
356c	7450	Rock Shaft Lifting Bracket Set Screw .....
2770	1511	" " Stop Dog with 356c .....
356c	7450	" " " " " Set Screw .....
2777	1511	Rock Shaft complete, Nos. 2763, 2768, 2770, 2778, 6337 and two 12242 .....
17039	—	Knee Lifter complete, Nos. 76D, 802D, 1521E, 2777, 5598, 12416, 13587, 13588 and two 178E .....

## THREAD UNWINDER

FOR FOUR LARGE SPOOLS OR FOUR LARGE CONES OF THREAD

NO.	PLATE	NAME
27623	2838	Spool Pin .....
155c	7450	" " Set Screw .....
41534	2838	" Rest .....

## THREAD UNWINDER

NO.	PLATE	NAME
41535	—	Spool Rest 41534 with 1149c and four each 155c and 27623 .....
1149c	7450	Spool Rest Set Screw .....
27940	2838	" Stand with 453c .....
41514	2838	" Weight, 4 in. diam., with 41515 .....
41515	7446	" " Centre Pin .....
27739	2838	Thread Cone (wood) .....
41633	2838	" Guard with 208E and four 41569 .....
41569	7446	" " Eyelet .....
41637	2838	" " Rod (lower) .....
41638	2838	" " " (upper) .....
41639	2838	" " " Coupling with two 456c .....
456c	7450	Thread Guard Rod Coupling Set Screw .....
41640	—	Thread Guard Rod complete, 30 in. long, Nos. 41637 to 41639 .....
453c	2831	Thread Guard Rod Set Screw .....
208E	7450	" " Screw .....
41537	2838	Thread Unwinder complete, Nos. 27940, 41535, 41633, 41640, three wood screws 1 in. No. 12 and four each 27739 and 41514 .....

## LIST OF PARTS COMPLETE FOR FEED ROLLS

TO BE USED WITH UNDER DRIVER NO. 27985

NO.	PLATE	NAME
27971	2830	Feed Roll (lower) with two 446c .....
446c	2831	" " " Set Screw .....
27972	2829	" " " Shaft .....
11411	2831	" " " " Collar with 453c .....
453c	2831	" " " " " Set Screw .....
27973	2830	" " " " Support .....
27974	2830	" " (upper) .....
27975	2831	" " " Bar .....
6533	2831	" " " " Collar with 460c .....
460c	2831	" " " " " Set Screw .....
27976	2831	" " " " Guide B r a c k e t with 454c .....
454c	2831	Feed Roll (upper) Bar Guide Bracket Set Screw .....
9532	2831	Feed Roll (upper) Bar Lifter with 9533 .....
81D	2831	" " " " " Hinge Screw .....
9533	2831	" " " " " Stop Pin .....
2065	2831	" " " " " Spring .....



NO.	PLATE	NAME
27640	7468	Treadle Pitman complete, Nos. 2762, 9079 and 27637 to 27639.....
2878	1165	Treadle Stand.....
2762	2642	" Stop Collar with 362F.....
362F	2642	" " " Set Screw.....
27642	—	Treadle complete, Nos. 2878, 9082, 27636 and four wood screws 1 in. No. 16.....
27643	—	Treadle and Pitman complete, Nos. 27640 and 27642.....
27984	—	Transmitter complete, Nos. 348E, 1092E, 1093c, 1507J, 1513J, 2718, 27750 to 27752, 27754, 27755, 27757, 27760, 27765, 27767, 27769, 27981, 27983, two each 1143c, 27753, 27795, three wood screws 2 in. No. 16 and twenty-two 25303.....
27985	—	Under Driver (ball bearing) lever pressure, two speed, right hand, complete, Nos. 27070, 27643 and 27984.....

### OBSOLETE PARTS

NO.	PLATE	NAME
13815	—	Needle Bar Connecting Stud with 1904 and two 640c, use 13896.....
640c	7450	Needle Bar Connecting Stud Clamping Screw for 13815.....

### NUMERICAL LIST OF PARTS

NO.	PLATE	NAME
55D	7449	Tape Holder Cover Hinge Screw for 28994
74E	7444	Feed Regulator Hinge Screw.....
76D	7446	Lifting Lever Connecting Rod Joint Hinge Screw for 13725 and 17039.....
81D	2831	Feed Roll (upper) Bar Lifter Hinge Screw for 27980.....
135D	7450	Corder Screw for 28561.....
138E	7450	Arm Screw (right).....
144D	7450	" Shaft Screw.....
145E	7450	Crank Connecting Rod Cap Screw for 13799.....
145E	7450	Feed Lifting Rock Shaft Connecting Rod Cap Screw for 13808.....
155c	7450	Thread Unwinder Spool Pin Set Screw for 41535.....
157J	7444	Feed Lifting Rock Shaft Crank Clamping Screw for 2509.....
175D	7444	Corder Arm Adjusting Screw for 28555.....
175E	7444	Needle Bar Connecting Stud Clamping Screw for 13896.....
178E	7450	Bell Crank Bracket Screw for 13725 and 17039.....
190D	7442	Face Plate Screw for 52-54 Machine.....
190D	7442	" " (upper) Screw for 52-74 Machine.....
190D	7442	Presser Foot Screw.....
190D	7442	Thread Controller Post Screw.....
191c	7450	Feed Dog Screw.....
208E	7450	Thread Unwinder Thread Guard Screw for 41633.....
210D	7450	Balance Wheel Oil Cover Screw.....
217F	7450	Looper Carrier Shaft Set Screw for 13811.....
219D	7450	Thread Guide (side of arm) Screw.....
233D	7442	" Controller Spring Screw for 13847.....
237F	7450	Looper Carrier Set Screw for 13864.....
263E	7450	Pressure Regulating Thumb Screw.....
284D	7449	Tape Holder Thumb Screw for 26065.....
286D	7450	Arm Side Cover Thumb Screw.....
286D	7450	Tape Holder Disc Hub Thumb Screw for 26062.....
286D	7450	Tape Holder Tension Adjusting Collar Thumb Screw for 26073.....
307c	7450	Feed Lifting Rock Shaft Screw Centre...

NO.	PLATE	NAME
307c	7450	Feed Rock Shaft Screw Centre.....
315c	2642	" Bar Screw Centre.....
348E	2642	Under Driver Dress Guard Screw for 27984.....
354c	2642	Under Driver Treadle Pitman Rod Clamp Screw for 9079.....
356c	7450	Rock Shaft Knee Arm Hub Set Screw for 2766.....
356c	7450	Rock Shaft Knee Plate Set Screw for 2767
356c	7450	" " Lifting Bracket Hook Set Screw for 6337.....
356c	7450	Rock Shaft Lifting Bracket Set Screw for 6337.....
356c	7450	Rock Shaft Stop Dog Set Screw for 2770.
362F	2642	Under Driver Treadle Stop Collar Set Screw for 2762.....
375c	7450	Crank Connecting Rod Hinge Screw.....
375c	7450	Feed Lifting Rock Shaft Connecting Rod Hinge Screw.....
378c	7444	Feed Connecting Link Hinge Screw (long)
378c	7444	" Forked Connection Hinge Screw....
380c	7444	" Connecting Link Hinge Screw (short)
435c	2831	" Roll Pulley (grooved) Set Screw for 27979.....
435c	2831	Needle Bar Crank Set Screw for 13816....
443c	7450	Arm Shaft Flanged Bushing (front) Set Screw.....
446c	2831	Arm Shaft Flanged Bushing (back) Set Screw.....
446c	2831	Feed Roll (lower) Set Screw for 27971....
448c	7450	Balance Wheel Set Screw for 13796.....
448c	7450	Feed and Feed Lifting Eccentric Set Screw for 13803.....
448c	7450	Looper Carrier Shaft Bushing Set Screw.
448c	7450	Oscillating Rock Shaft Hinge Pin Set Screw.....
451c	2831	Under Driver Driving Pulley Set Screw for 27982.....
453c	2831	Feed Roll (lower) Shaft Collar Set Screw for 11411.....
453c	2831	Feed Roll (upper) Shaft Set Screw for 27977.....
453c	2831	Presser Bar Lifting Bracket Set Screw for 2953.....
453c	2831	Thread Unwinder Thread Guard Rod Set Screw for 27940.....

NO.	PLATE	NAME
454c	2831	Feed Roll (upper) Bar Guide Bracket Set Screw for 27976.....
456c	7450	Thread Unwinder Thread Guard Rod Coupling Set Screw for 41639.....
460c	2831	Feed Roll (upper) Bar Collar Set Screw for 6533.....
465c	7444	Feed Rock Shaft Crank Set Screw for 2048.....
597c	2642	Under Driver Shaft Driving Pulley Clamp- ing Screw for 27070.....
620F	7445	Needle Set Screw for 13558.....
637c	7442	Tension Screw Stud for 13888.....
640c	7450	Needle Bar Connecting Stud Clamping Screw for 13815, obsolete.....
691F	7450	Throat Plate Screw.....
736D	7449	Tape Holder Foot Thumb Screw for 26064 and 26325.....
747D	7444	Feed Regulator Thumb Screw.....
794E	7444	Needle Bar Connecting Link Adjusting Screw for 13582.....
802D	7450	Lifting Lever Hinge Screw for 13725 and 17039.....
853c	7450	Looper Set Screw for 13864.....
878D	2641	Under Driver Cone Pulley Oil Hole Stop Screw for 27750.....
880E	7450	Arm Screw (left).....
881c	7444	Needle Bar Connecting Link Hinge Screw
883B	7445	Thread Take-up Plate Screw.....
898D	7450	Arm Oil Tube Bracket Screw.....
898F	7450	Tension Bracket Screw.....
910c	2831	Feed Roll (upper) Bracket Set Screw for 27977.....
970D	7446	Bed Frame Thumb Screw for 13697.....
1058c	7445	Presser Bar Lifter Hinge Screw.....
1092E	2642	Under Driver Lever Hinge Screw for 27984
1093c	2642	" " " Adjusting Screw f o r 27984.....
1122c	2641	Under Driver Driving Pulley Shaft Screw Bearing Ball Case (left) Set Screw for 27983.....
1122c	2641	Under Driver Driving Pulley Shaft Screw Bearing Ball Case (right) Set Screw for 27983.....
1143c	2641	Under Driver Cone Pulley Ball Bearing Adjusting Ring Set Screw for 27984....
1149c	7450	Thread Unwinder Spool Rest Set Screw for 41535.....

NO.	PLATE	NAME
1253c	7445	Looper Driving Shaft Crank Set Screw for 13812.....
1253c	7445	Looper Driving Shaft Link Hinge Pin Set Screw for 13818.....
1293c	7450	Needle Bar Crank Position Screw for 13816.....
1337c	2831	Under Driver Driving Pulley Set Screw for 27981.....
1507j	2642	Under Driver Lever Hinge Screw Nut for 27984.....
1513j	2642	Feed Lifting Rock Shaft Screw Centre Nut.....
1513j	2642	Feed Rock Shaft Screw Centre Nut.....
1513j	2642	Under Driver Lever Adjusting Screw Nut for 27984.....
1518E	7450	Crank Connecting Rod Hinge Screw Nut
1518E	7450	Feed Lifting Rock Shaft Connecting Rod Hinge Screw Nut.....
1519E	7450	Feed Bar Screw Centre Nut.....
1520E	7444	" Connecting Link Hinge Screw Nut.....
1520E	7444	" Forked Connection Hinge Screw Nut.....
1520E	7444	Presser Bar Lifter Hinge Screw Nut.....
1521E	7446	Lifting Lever Connecting Rod Lock Nut for 13725 and 17039.....
1547D	7442	Tension Screw Stud Nut for 13888.....
1560C	7442	" Regulating Thumb Nut for 13888.....
1813	7444	Feed Lifting Rock Shaft Crank Roller and Stud for 2509.....
1904	7444	Needle Bar Connecting Stud Roller (roller only) for 13815 and 13896.....
2039	7444	Feed Connecting Link.....
2046	—	Feed Rock Shaft complete, Nos. 2047 and 2048.....
2047	7440	Feed Rock Shaft for 2046.....
2048	7444	" " " Crank with 465c, for 2046.....
2049	7444	Feed Rock Shaft Crank Pin.....
2058	7441	Presser Bar.....
2065	2831	Feed Roll (upper) Bar Spring for 27980..
2070	7445	Presser Bar Spring Washer.....
2164	7444	Feed Regulator.....
2273	7445	Needle Clamp Pin.....
2509	7444	Feed Lifting Rock Shaft Crank with 157j and 1813, for 13807.....
2718	2642	Under Driver Dress Guard Screw Washer for 27984.....

NO.	PLATE	NAME
2762	2642	Under Driver Treadle Stop Collar with 362r, for 27640.....
2763	1511	Rock Shaft for 2777 and 4880.....
		Nos. 2765 TO 2767 FOR 2768.
2765	1511	Rock Shaft Knee Arm.....
2766	1511	" " " " Hub with 356c....
2767	1511	" " " " Plate with 356c.....
2768	—	Rock Shaft Knee Arm complete for 2777, Nos. 2765 to 2767.....
2770	1516	Rock Shaft Stop Dog with 356c, for 2777 and 4880.....
2777	1511	Rock Shaft complete for 17039, Nos. 2763, 2768, 2770, 2778, 6337 and two 12242..
2778	1511	Rock Shaft Lifting Bracket Hook for 2777
2878	1165	Under Driver Treadle Stand for 27642...
2921	7442	Tension Disc for 13888.....
2932	2830	Feed Roll (upper) Shaft for 27980.....
2953	7445	Presser Bar Lifting Bracket with 453c...
2978	1514	Drip Pan for 13697.....
3100	7445	Presser Bar Spring.....
4389	7445	Arm Dowel Pin.....
4822	7447	Wrench for 1521 and 1547 (Accessories)..
4879	7448	Chain Connecting Link for 4885.....
4880	1516	Rock Shaft complete for 13725, Nos. 2763, 2770, 7125, 12243 and two each 6337 and 12242.....
		Nos. 4881 TO 4884 FOR 4885.
4881	1516	Treadle.....
4882	7448	" Shaft.....
4883	7448	" Spring.....
4884	1516	" Stand.....
4885	1516	Treadle complete for 13725, Nos. 4879, 4881 to 4884 and two wood screws 1 in. No. 16.....
5596	7448	Bell Crank for 5598.....
5598	7448	Bell Crank complete for 13725 and 17039, Nos. 5596, 5599, 5601 and 5735.....
5599	7448	Bell Crank Bracket for 5598.....
5601	7446	" " Hinge Pin for 5598.....
5670	—	Chain, length 26 in. to 35 in., for 13725...
5735	7446	Bell Crank Spring for 5598.....
6337	1511	Rock Shaft Lifting Bracket with two 356c, for 2777 and 4880.....
6533	2831	Feed Roll (upper) Bar Collar with 460c, for 27980.....

## NUMERICAL LIST OF PARTS

NO.	PLATE	NAME
7125	1516	Rock Shaft Lifting Bracket Hook for 4880.....
7263	7446	Bed Frame Hinge Connection (long) for 13697.....
7958	2642	Under Driver Driving Pulley Friction Ring Stop Pin for 27981.....
8908	7447	Wrench for 1519 and 1520 (Accessories)...
8909	7447	“ “ 1513 and 1518 (Accessories)...
9079	7468	Under Driver Treadle Pitman Rod Clamp with 354c, for 27640.....
9082	2642	Under Driver Treadle Bearing Cotter Pin for 27642.....
9532	2831	Feed Roll (upper) Bar Lifter with 9533, for 27980.....
9533	2831	Feed Roll (upper) Bar Lifter Stop Pin for 9532.....
11118	7446	Bed Frame Cushion (leather) for 13697..
11411	2831	Feed Roll (lower) Shaft Collar with 453c, for 27980.....
12242	1511	Rock Shaft Hanger with two wood screws 1 in. No. 10, for 2777 and 4880.....
12243	1516	Rock Shaft Lifting Bracket Hook for 4880
12361	7446	Machine Hinge Connection for 44140....
12405	7446	“ Rest, felt (Accessories).....
12416	7446	Lifting Lever Connecting Rod Joint for 13725 and 17039.....
12459	2641	Under Driver Cone Pulley Oil Hole Stop Screw Washer (leather) for 27750, ..... per 100
13211	7446	Tape Holder Tension Adjusting Spring for 26074.....
13516	7445	Looper Carrier Shaft.....
13558	7459	Needle Clamp with four 620F or 50014F, for 1/8 in. to 1/4 in. gauge.....
13581	7441	Needle Bar (hollow).....
13582	7444	“ “ Connecting Link with 794E..
13587	7448	Lifting Lever for 13725 and 17039.....
13588	7448	“ “ Connecting Rod for 13725 and 17039.....
13589	7442	Tension Disc Steady Pin for 13887.....
13589	7442	“ Thread Guide Pin for 13887.....
13594	7445	Thread Take-up Plate.....
13635	1514	Drip Pan with four 1 in. wire nails.....
13697	1511	Bed Frame with 970b, 2978, 7263, 14098, two 14008 and four each 11118 and wood screws 1 1/4 in. No. 12.....
13710	7442	Tension Spring for 13888.....

## NUMERICAL LIST OF PARTS

NO.	PLATE	NAME
13725	—	Foot Lifter complete, Nos. 76b, 802b, 1521E, 4880, 4885, 5598, 5670, 12416, 13587, 13588 and two 178E.....
*13789	—	Arm.....
13790	to 13792.	Nos. cancelled.
13793	7440	Arm Shaft.....
13794	7440	“ “ Flanged Bushing (back).....
13795	7440	“ “ “ “ (front).....
13796	7441	Balance Wheel, 2 3/8 in. pulley, with two 448c.....
13797	7441	Balance Wheel Oil Cover.....
*13798	—	Bed.....
13799	7441	Crank Connecting Rod with 13800 and two 145E.....
*13800	—	Crank Connecting Rod Cap for 13799..
13801	7458	Face Plate (upper) for 52-74 Machine..
13802	7443	Feed Bar.....
13803	7444	“ and Feed Lifting Eccentric with 448c.....
13804	7444	Feed and Feed Lifting Eccentric Sleeve
13805	7440	“ Forked Connection.....
13806	7440	“ Lifting Rock Shaft for 13807....
13807	—	Feed Lifting Rock Shaft complete, Nos. 2509 and 13806.....
13808	7440	Feed Lifting Rock Shaft Connecting Rod with 43977 and two 145E.....
13809	7445	Looper.....
13811	7441	“ Driving Shaft with 217F.....
13812	7445	“ “ “ Crank with two 1253c.....
13813	7445	Looper Driving Shaft Link.....
13814	7445	“ “ “ “ Hinge Pin....
13815	—	Needle Bar Connecting Stud with 1904 and two 640c, obsolete, use 13896....
13816	7440	Needle Bar Crank with 435c and 1293c..
13818	7445	Oscillating Rock Shaft with 1253c.....
13819	7445	“ “ “ Hinge Pin.....
13820	7445	“ “ “ “ Bushing
13821	to 13830.	Nos. cancelled.
		Nos. 13831 to 13833 for 13834.
13831	7442	Arm Oil Tube (left) with 49092, for oiling 13811.....
13832	7442	Arm Oil Tube (right) with 49092, for oiling 13813.....
13833	—	Arm Oil Tube Bracket.....

From the library of: Diamond Needle Corp

NO.	PLATE	NAME
13834	7442	Arm Oil Tube Bracket 13833 with 13831 and 13832.....
13835	7458	Face Plate (lower) for 52-74 Machine.....
13836	7445	Looper Carrier Shaft Bushing.....
13844	7442	Thread Controller Post for 13847.....
13845	7442	" " Spring for 13847.....
13846	7442	" " Thread Guide.....
13847	—	Thread Controller complete, Nos. 233b, 13844 and 13845.....
13849	7441	Face Plate for 52-54 Machine.....
13850	—	Thread Guide (back of arm) four holes, for 13851.....
13851	7456	Thread Guide (back of arm) 13850 with 13862.....
13852	7459	Thread Guide (side of arm) four holes....
13853	—	" " (top of arm) four holes, for 13854.....
13854	7457	Thread Guide (top of arm) 13853 with 13862.....
13862	7442	Arm Oil Tube with 29599, for oiling 13799 and 13804, for 13851 and 13854.....
13863	7459	Needle Clamp with four 50014F, for $\frac{3}{8}$ in. gauge and above.....
13864	7459	Looper Carrier with two 237F and four 853c
13887	7470	Tension Bracket with eight 13589, for 13888.....
13888	—	Tension Bracket complete, Nos. 13887, four each 637c, 1547b, 1560c, 13710 and eight 2921.....
13896	7444	Needle Bar Connecting Stud with 1904 and two 175E.....
14008	7446	Bed Frame Hinge Connection Pin for 13697.....
14098	7446	Bed Frame Hinge Connection (short) for 13697.....
15196	7441	Arm Side Cover.....
17039	—	Knee Lifter complete, Nos. 76b, 802b, 1521E, 2777, 5598, 12416, 13587, 13588 and two 178E.....
21350	7444	Feed Regulator Thumb Screw Stop.....
25303	2641	Under Driver Cone Pulley Ball, size $\frac{1}{4}$ in., for 27984..... per 100
25303	2641	Under Driver Driving Pulley Shaft Ball, size $\frac{1}{4}$ in., for 27760 and 27765... per 100
25303	2641	Under Driver Driving Pulley Shaft Screw Bearing Ball Case (left) Friction Stud Ball, size $\frac{1}{4}$ in., for 27760..... per 100

NO.	PLATE	NAME
25790	7449	Corder Arm Hinge Pin for 28555.....
26026	7447	Screw Driver, large (Accessories).....
26061	989	Tape Holder Bracket Wire with Disc for 26063.....
26062	989	Tape Holder Disc (adjustable) with 286b and 35925, for 26063.....
26063	989	Tape Holder (straight) 8 in. disc, complete, for 26065, Nos. 26061 and 26062..
26064	7448	Tape Holder Foot with 736b and three wood screws 1 in. No. 12, for 26343....
26065	—	Tape Holder with Foot complete, Nos. 26063 and 26325.....
26066	989	Tape Holder Bracket Wire for 26067....
26067	—	Tape Holder Bracket Wire complete for 26074, Nos. 26066, 26068 and 26072...
26068	989	Tape Holder Disc for 26067 and 26071....
26069	989	" " " Hub for 26071.....
26070	7446	" " " " Rivet for 26071, ..... per 100
26071	—	Tape Holder Disc complete for 26074, Nos. 26068, 26069 and three 26070....
26072	989	Tape Holder Tape Guide for 26067.....
26073	7449	" " Tension Adjusting Collar with 286b, for 26074.....
26074	989	Tape Holder (offset) 10 in. disc., complete, for 26343, Nos. 13211, 26067, 26071 and 26073.....
26210	5483	Presser Foot for 28561.....
26325	7448	Tape Holder Foot with 736b and three wood screws 1 in. No. 12, for 26065....
26343	—	Tape Holder with Foot complete, Nos. 26064 and 26074.....
26354	1512	Corder Cord Guide Eyelet for 26356.....
26355	1512	" " " Plate for 26356.....
26356	1512	Corder Cord Guide (table) complete for 52-54 Machine, Nos. 26355 and seven 26354.....
26357	1512	Corder Cord Tension Plate for 26359....
26358	1512	" " " Pin for 26359.....
26359	1512	Corder Cord Tension (bed) complete for 52-54 Machine, Nos. 26357 and ten 26358.....
26485	7447	Screw Driver, small (Accessories).....
27070	1165	Under Driver Shaft Driving Pulley (sectional, grooved) 10 in. diam., $1\frac{1}{8}$ in. bore, with two 597c, for 27985.....
27598	—	Under Driver Driving Pulley Friction Ring (leather) for 27981.....

NO.	PLATE	NAME
27623	2838	Thread Unwinder Spool Pin for 41535...
27636	1165	Under Driver Treadle for 27642.....
Nos. 27637 to 27639 FOR 27640.		
27637	7468	Under Driver Treadle Pitman Rod (lower)
27638	2642	" " " " " "
Spring.....		
27639	7468	Under Driver Treadle Pitman Rod (upper)
27640	7468	Under Driver Treadle Pitman complete for 27643, Nos. 2762, 9079 and 27637 to 27639.....
27642	—	Under Driver Treadle complete for 27643, Nos. 2878, 9082, 27636 and four wood screws 1 in. No. 16.....
27643	—	Under Driver Treadle and Pitman com- plete for 27985, Nos. 27640 and 27642.
27739	2838	Thread Unwinder Thread Cone (wood) for 41537.....
Nos. 27750 to 27755 FOR 27984.		
27750	7468	Under Driver Cone Pulley (grooved) two speed, $3\frac{1}{8}$ in. and $5\frac{3}{8}$ in. diam., with 878b and 12459.....
27751	2641	Under Driver Driving Pulley Shaft Ball Bearing Collar.....
27752	2641	Under Driver Driving Pulley Shaft Ball Bearing Collar Pin.....
27753	2641	Under Driver Cone Pulley Ball Bearing Adjusting Ring.....
27754	2641	Under Driver Driving Pulley Shaft Screw Bearing Ball Case (left) Friction Stud Extension Pin.....
27755	7468	Under Driver Dress Guard.....
27757	2641	" " Driving Pulley Shaft for 27984.....
27758	2641	Under Driver Driving Pulley Shaft Ball Safety Washer for 27760 and 27765....
27759	2641	Under Driver Driving Pulley Shaft Screw Bearing Ball Case (left) for 27760....
27760	—	Under Driver Driving Pulley Shaft Screw Bearing Ball Case (left) complete for 27984, Nos. 27758, 27759, 27761 to 27763 and twelve 25303.....
Nos. 27761 to 27763 FOR 27760.		
27761	2641	Under Driver Driving Pulley Shaft Screw Bearing Ball Case (left) Friction Stud.

NO.	PLATE	NAME
27762	2641	Under Driver Driving Pulley Shaft Screw Bearing Ball Case (left) Friction Stud Ball Plate.....
27763	2641	Under Driver Driving Pulley Shaft Screw Bearing Ball Case (left) Friction Stud Ball Plate Washer.....
27764	2641	Under Driver Driving Pulley Shaft Screw Bearing Ball Case (right) for 27765....
27765	—	Under Driver Driving Pulley Shaft Screw Bearing Ball Case (right) complete for 27984, Nos. 27758, 27764 and eight 25303.....
27767	7468	Under Driver Lever with 27768 and two 27878, for 27984.....
27768	2642	Under Driver Lever Brake (leather, two pieces) for 27767.....
27769	2642	Under Driver Lever Spring for 27984....
27795	2641	" " Cone Pulley Ball Bearing Adjusting Ring Set Screw Washer for 27984..... per 100
27878	2642	Under Driver Lever Brake Rivet for 27767
27940	2838	Thread Unwinder Spool Stand with 453c, for 41537.....
Nos. 27971 to 27979 FOR 27980.		
27971	2830	Feed Roll (lower) with two 446c.....
27972	2829	" " " Shaft.....
27973	2830	" " " " Support.....
27974	2830	" " (upper).....
27975	2831	" " " Bar.....
27976	2831	" " " " Guide Bracket with 454c.....
27977	2830	Feed Roll (upper) Bracket with 453c and 910c.....
27978	2829	Feed Roll Frame.....
27979	2829	" " Pulley (grooved) $9\frac{1}{8}$ in. diam., with 435c.....
27980	—	Feed Rolls complete for 27985, Nos. 81b, 2065, 2932, 6533, 9532, 11411, 27971 to 27979 and six wood screws $1\frac{1}{4}$ in. No. 12
27981	2829	Under Driver Driving Pulley (grooved) $5\frac{7}{8}$ in. diam., with 1337c, 7958, 27598 and 27982, for 27984.....
27982	2830	Under Driver Driving Pulley (grooved) $1\frac{1}{2}$ in. diam., with 451c, for 27981....



## NUMERICAL LIST OF PARTS

NO.	PLATE	NAME
27983	2829	Under Driver Frame with two 1122c, for 27984.....
27984	—	Under Driver Transmitter complete for 27985, Nos. 348E, 1092E, 1093C, 1507J, 1513J, 2718, 27750 to 27752, 27754, 27755, 27757, 27760, 27765, 27767, 27769, 27981, 27983, two each 1143c, 27753, 27795, three wood screws 2 in. No. 16 and twenty-two 25303.....
27985	—	Under Driver (ball bearing) lever pressure, two speed, right hand, complete, Nos. 27070, 27643 and 27984.....
28550	7453	Corder Arm with Tip and Cord Guides for 28555.....
28554	7453	Corder Arm Bracket for 28555.....
28555	7453	Corder Arm and Bracket complete for 28561, Nos. 175D, 25790, 28550 and 28554.....
28561	—	Corder complete for 52-54 Machine, Nos. 135D, 26210 and 28555.....
28570	5483	Presser Foot, for continuous cording from the right or left, for 52-54 Machine....
28571	5483	Presser Foot, for group cording, for 52-54 Machine.....
28994	2116	Tape Holder (5 in. diam.) complete, for under the bench, Nos. 55D, 36795, 36796 and two wood screws 1¼ in. No. 10....
29599	7442	Arm Oil Tube Packing (felt) for 13862, .....per 100
Nos. 30326 TO 30340 FOR 52-54 MACHINE.		
30326	5484	Presser Foot (tube) for reeding, leaving out the first needle from the left hand side.....
30327	4655	Presser Foot (hinged, tube).....
30328	5485	" " (tube) for two strips.....
30329	5484	" " " with two grooves on bottom, for reeding.....
30330	4655	Presser Foot (hinged, tube) for two strips
30331	5486	" " for braiding.....
30332	5487	" " " gathering.....
30333	5488	" " (tube) for two strips, for reeding between the first and second needles from the right hand side and the first and second needles from the left hand side.....

## NUMERICAL LIST OF PARTS

NO.	PLATE	NAME
30334	5489	Presser Foot (hinged, tube) leaving out the first needle from the right hand side
30335	5490	Presser Foot, for general work.....
30336	5488	Presser Foot (tube) with three grooves on bottom, for reeding.....
30337	5489	Presser Foot (tube).....
30338	4681	" " (strip folding) with five cord tubes.....
30339	5491	Presser Foot (strip folding) with tube for cording, leaving out the first needle from the right hand side and the second needle from the left hand side.....
30340	4681	Presser Foot (strip folding and cording) for covering two cords with two folded strips.....
Nos. 31081 TO 31086 FOR 52-54 MACHINE.		
31081	3031	Presser Foot (strip folding) with three cord tubes.....
31082	3031	Presser Foot (hinged, tube) for two strips for reeding.....
31083	3032	Presser Foot (hinged) for general work....
31084	3032	" " (double strip folding).....
31085	3033	" " with keel, slotted for tape.....
31086	3033	" " (tube) for two strips.....
Nos. 31088 TO 31101 FOR 52-54 MACHINE.		
31088	3091	Presser Foot (strip folding) for cloth work
31089	3092	" " " " " " woollen shirts, for folding the front plait and stitching to the body of the shirt in one operation.....
31090	5492	Presser Foot (hinged) for lap seam feller, leaving out the first needle from the right hand side and the second needle from the left hand side.....
31091	5491	Presser Foot (strip folding) for general work.....
31092	5492	Presser Foot (hinged, adjustable) for gathering.....
31093	4627	Presser Foot (strip folding) with two cord tubes between the first and second needles from the right hand side and the first and second needles from the left hand side.....
31094	5493	Presser Foot (tube) for two strips, for reeding.....

NO.	PLATE	NAME
31095	5493	Presser Foot (tube) for strip, lining and interlining, grooved on bottom for three steels.....
31096	5494	Presser Foot, for cording, with three cord tubes and guide for upper strip...
31097	5486	Presser Foot, for rims of soft hats.....
31098	5445	" " (strip folding) with guide for interlining, for woolen shirts for folding the front plait and stitching to the body of the shirt in one operation.....
31099	5485	Presser Foot (tube) for two strips and under strip.....
31100	5495	Presser Foot (side hinged) for general work.....
31101	5494	Presser Foot, for strip cording with guides for upper and under strips and three cord tubes.....
35143	7447	Tweezers, 4 in. (Accessories).....
35925	7449	Tape Holder Disc Hub for 26062.....
36569	7447	Oiler with 36571, for 36570.....
36570	—	" 36569, filled with oil (Accessories)...
36571	7447	" Spout, 1 3/4 in. long, with 36807, for 36569.....
36795	—	Tape Holder Body for 28994.....
36796	—	" " Cover for 28994.....
36807	7446	Oiler Spout Washer (leather) for 36571...
41400	7447	Machine Rest Pin (wood) 3 1/8 in. long (Accessories).....
41514	2838	Thread Unwinder Spool Weight, 4 in. diam., with 41515, for 41537.....
41515	7446	Thread Unwinder Spool Weight Centre Pin for 41514.....
41534	2838	Thread Unwinder Spool Rest for 41535...
41535	—	" " " " 41534 with 1149c and four each 155c and 27623, for 41537.....
41537	2838	Thread Unwinder complete, for four large spools or four large cones of thread, Nos. 27940, 41535, 41633, 41640, three wood screws 1 in. No. 12 and four each 27739 and 41514.....
41569	7446	Thread Unwinder Thread Guard Eyelet for 41633.....
41633	2838	Thread Unwinder Thread Guard with 208E and four 41569, for 41537.....

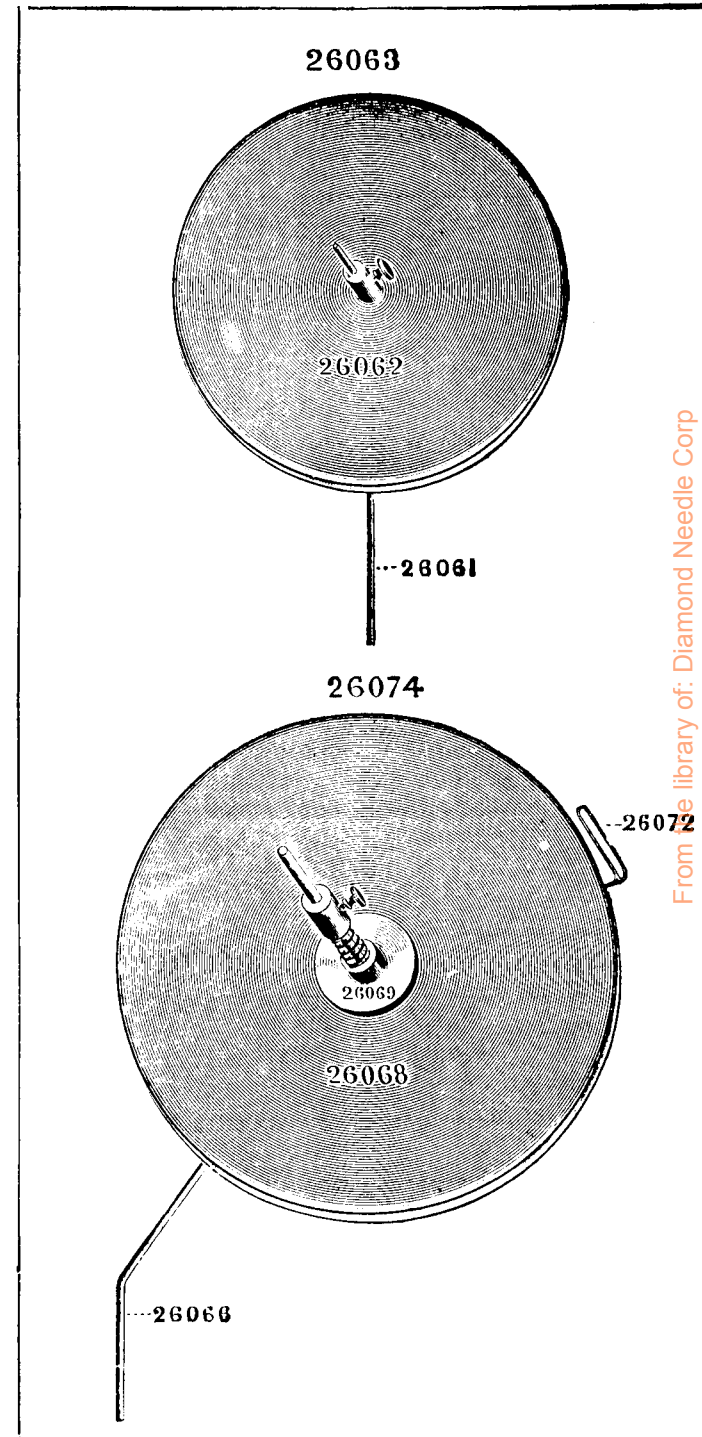
NO.	PLATE	NAME
Nos. 41637 TO 41639 FOR 41640.		
41637	2838	Thread Unwinder Thread Guard Rod (lower).....
41638	2838	Thread Unwinder Thread Guard Rod (upper).....
41639	2838	Thread Unwinder Thread Guard Rod Coupling with two 456c.....
41640	—	Thread Unwinder Thread Guard Rod complete, 30 in. long, for 41537, Nos. 41637 to 41639.....
*43977	—	Feed Lifting Rock Shaft Connecting Rod Cap for 13808.....
44139	7446	Machine Hinge Plate for 44140.....
44140	—	Machine Hinge complete, Nos. 12361, 44139 and wood screw 1 1/4 in. No. 14.....
Nos. 48082 TO 48091 FOR 52-54 MACHINE.		
48082	5387	Feed Dog.....
48083	5388	" ".....
48084	5389	" ".....
48085	5390	" ".....
48086	5391	" ".....
48087	5392	" " for gathering.....
48088	5393	" " " ".....
48089	5394	" ".....
48090	5395	" ".....
48091	5396	" ".....
48102	5387	Throat Plate for 48082.....
48103	5388	" " " 48083.....
48104	5389	" " " 48084.....
48105	5390	" " " 48085.....
48106	5391	" " " 48086.....
48107	5392	" " " 48087.....
48108	5393	" " " 48088.....
48109	5394	" " " 48089.....
48110	5395	" " " 48090.....
48111	5396	" " " 48091.....
Nos. 48462 TO 48464 FOR 52-74 MACHINE.		
48462	5397	Feed Dog.....
48463	5398	" ".....
48464	5399	" ".....
48477	5496	Presser Foot (hinged) for 52-74 Machine.
48497	5397	Throat Plate (thin stock) for 48462.....
48498	5398	" " " " " 48463.....
48499	5399	" " " " " 48464.....

NO.	PLATE	NAME
49092	7442	Arm Oil Tube Packing (felt) for 13831 and 13832.....
50014F	7445	Needle Set Screw, for $\frac{3}{16}$ in. gauge and above, for 13558 and 13863.....
50062J	7450	Thread Guide (top of arm) Screw.....
52016	7445	Presser Bar Lifter.....
54897	7442	Arm Oil Cup.....
56006	7442	" Shaft Flanged Bushing (back) Oil Pad (braided cotton).....
56006	7442	Arm Shaft Flanged Bushing (front) Oil Pad (braided cotton).....

SINGER Needles should be used in SINGER Machines  
 These Needles and their Containers are marked with the Company's Trade Mark "SIMANCO.\*\*" 1

Needles in Containers marked "FOR SINGER MACHINES" are NOT SINGER made needles. 2

PLATE 989—ONE-FOURTH SIZE



From the library of: Diamond Needle Corp

PLATE 1512—FULL SIZE

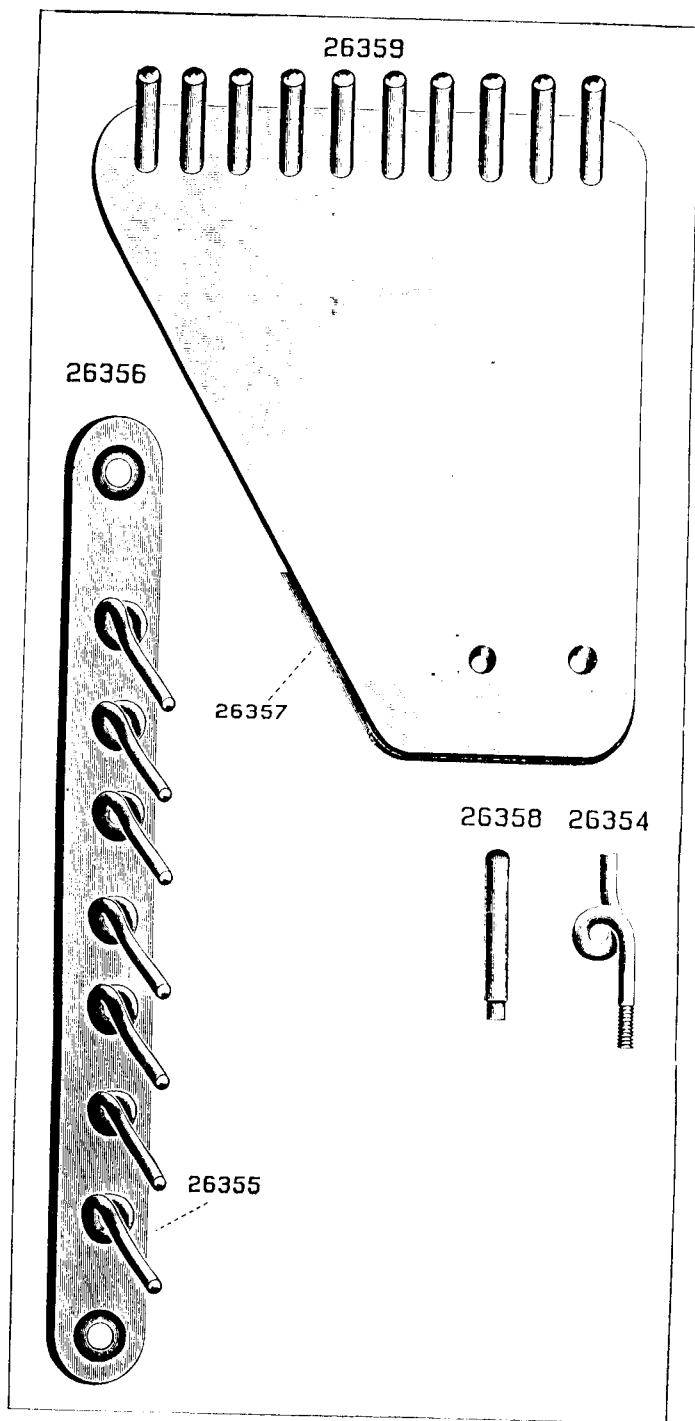


PLATE 1514—ONE-FOURTH SIZE

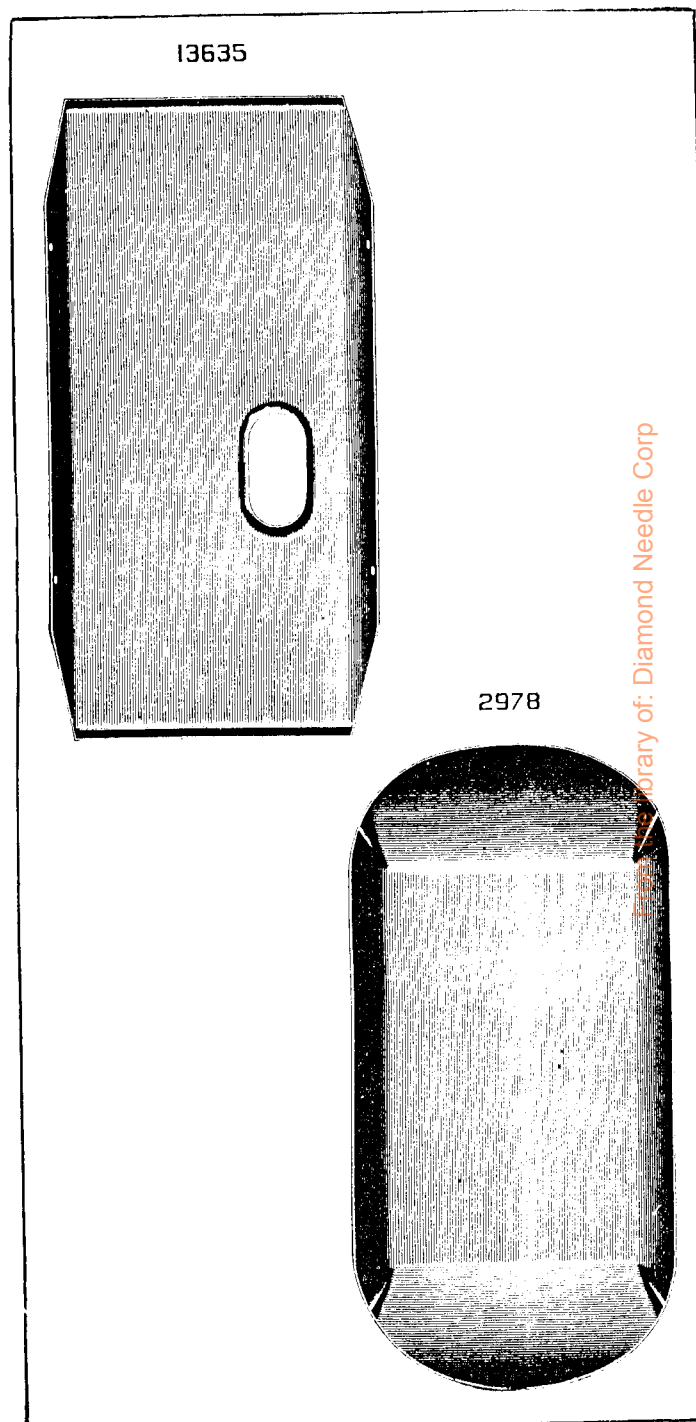


PLATE 1516—ONE-FOURTH SIZE

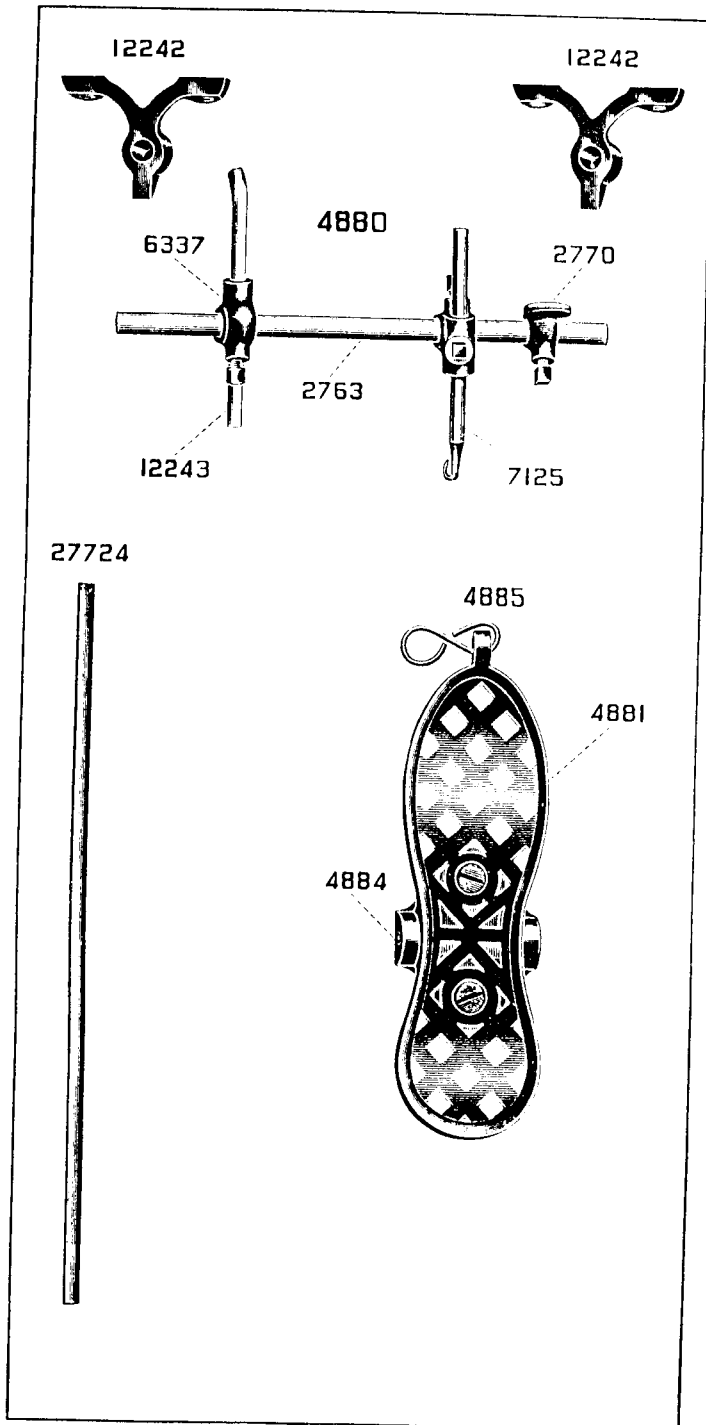
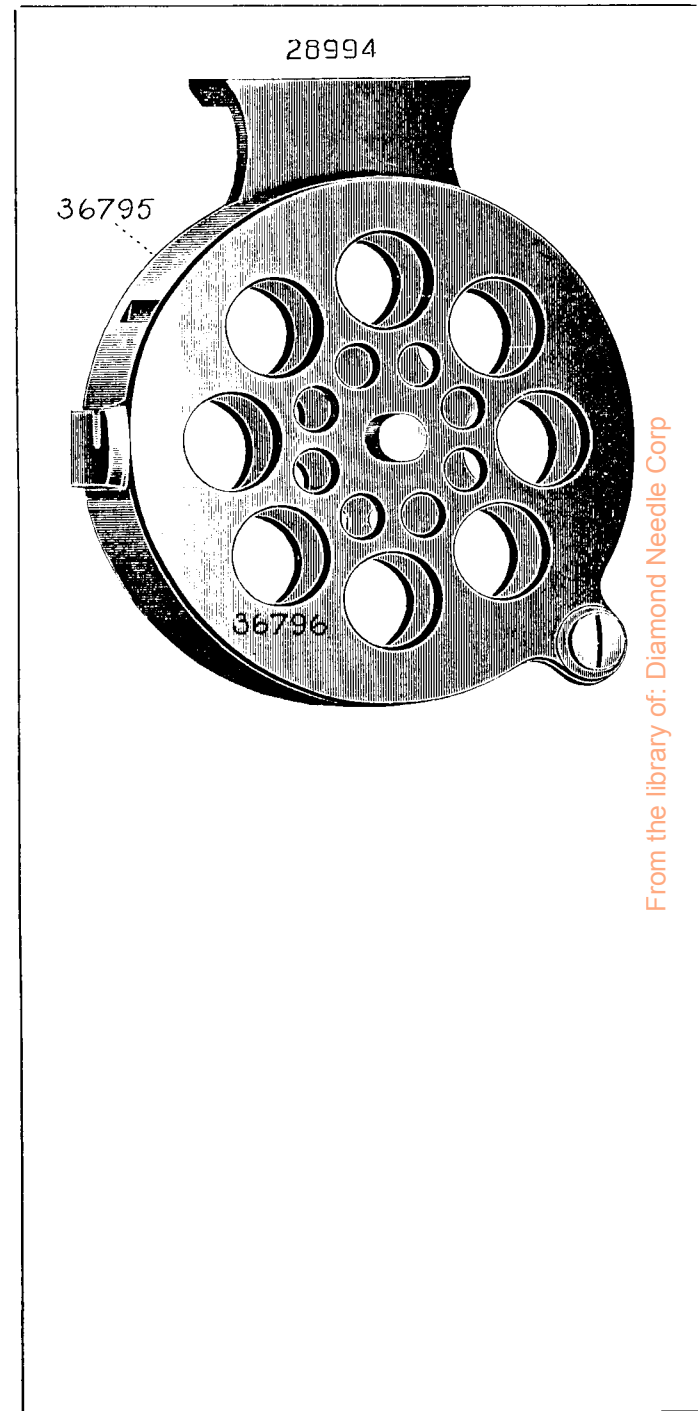


PLATE 2116 - ONE-HALF SIZE



From the library of: Diamond Needle Corp

PLATE 2641—FULL SIZE

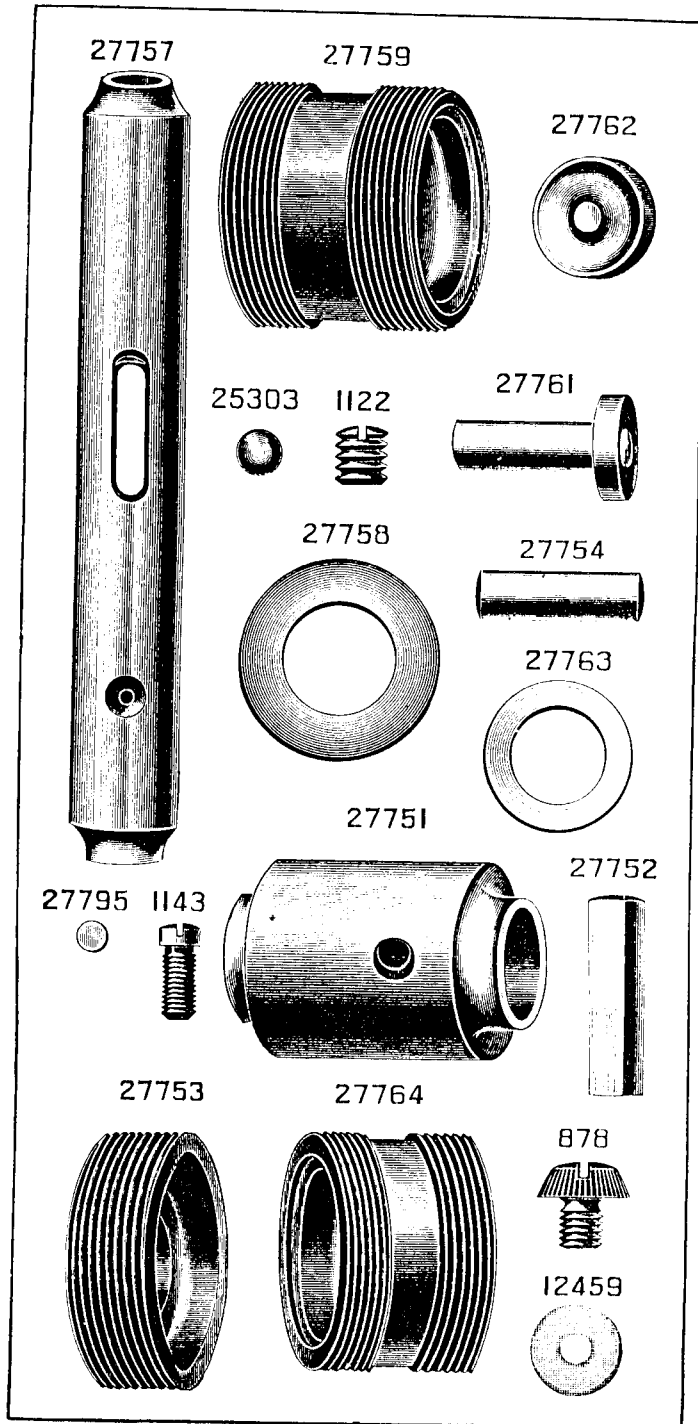


PLATE 2642—FULL SIZE

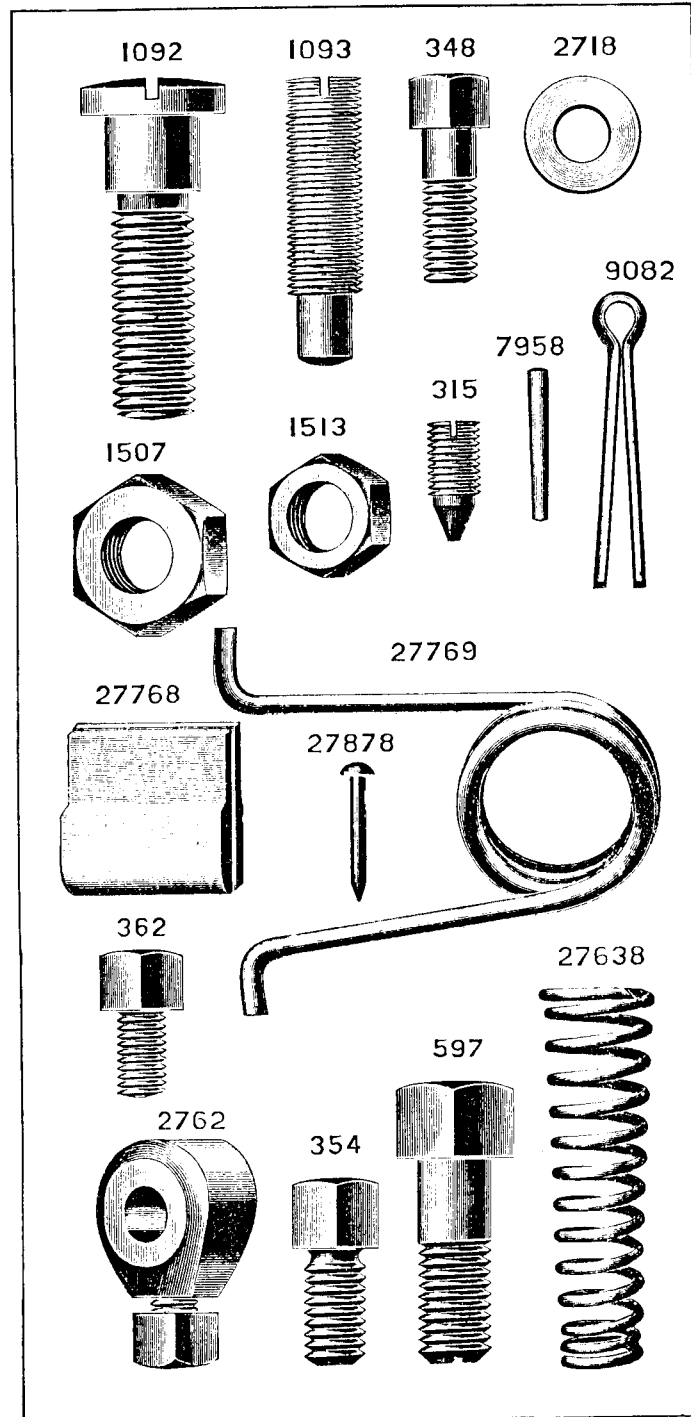


PLATE 2829—ONE-FOURTH SIZE

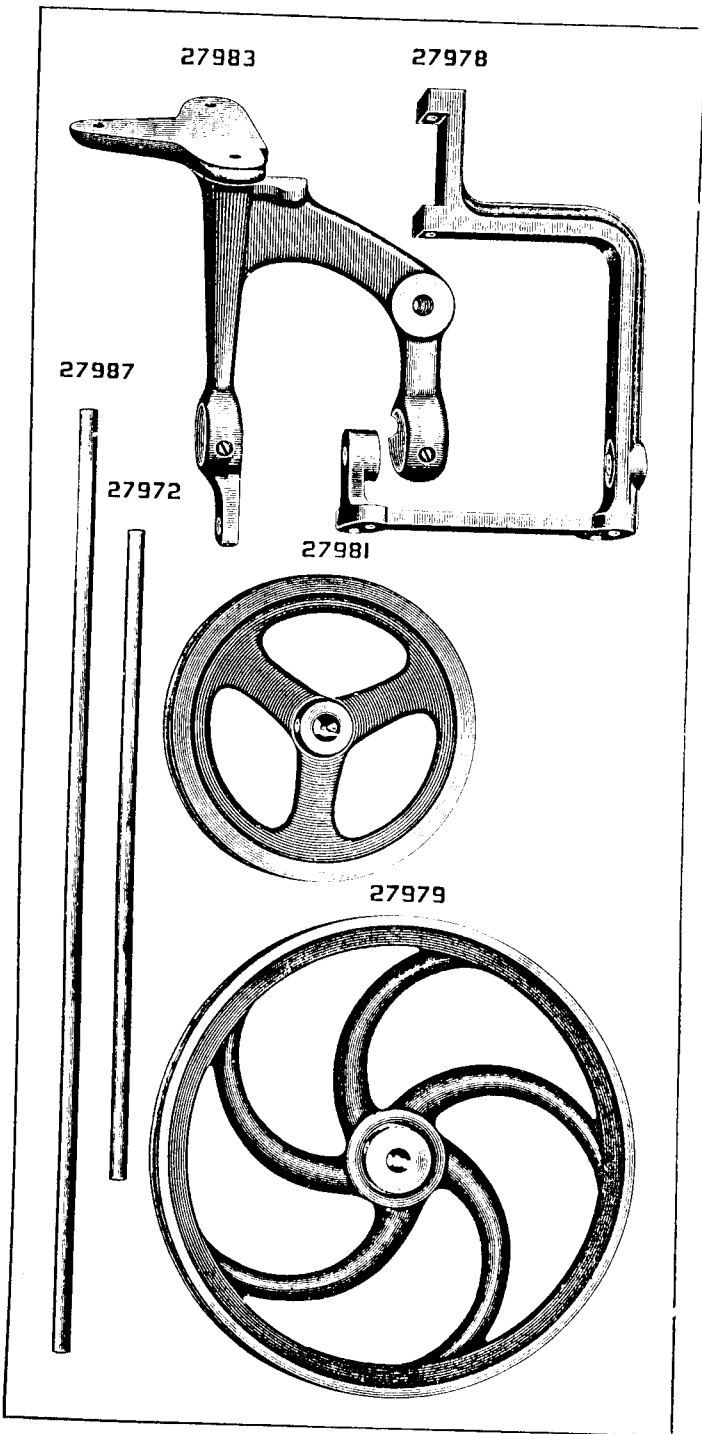


PLATE 2830—ONE-HALF SIZE

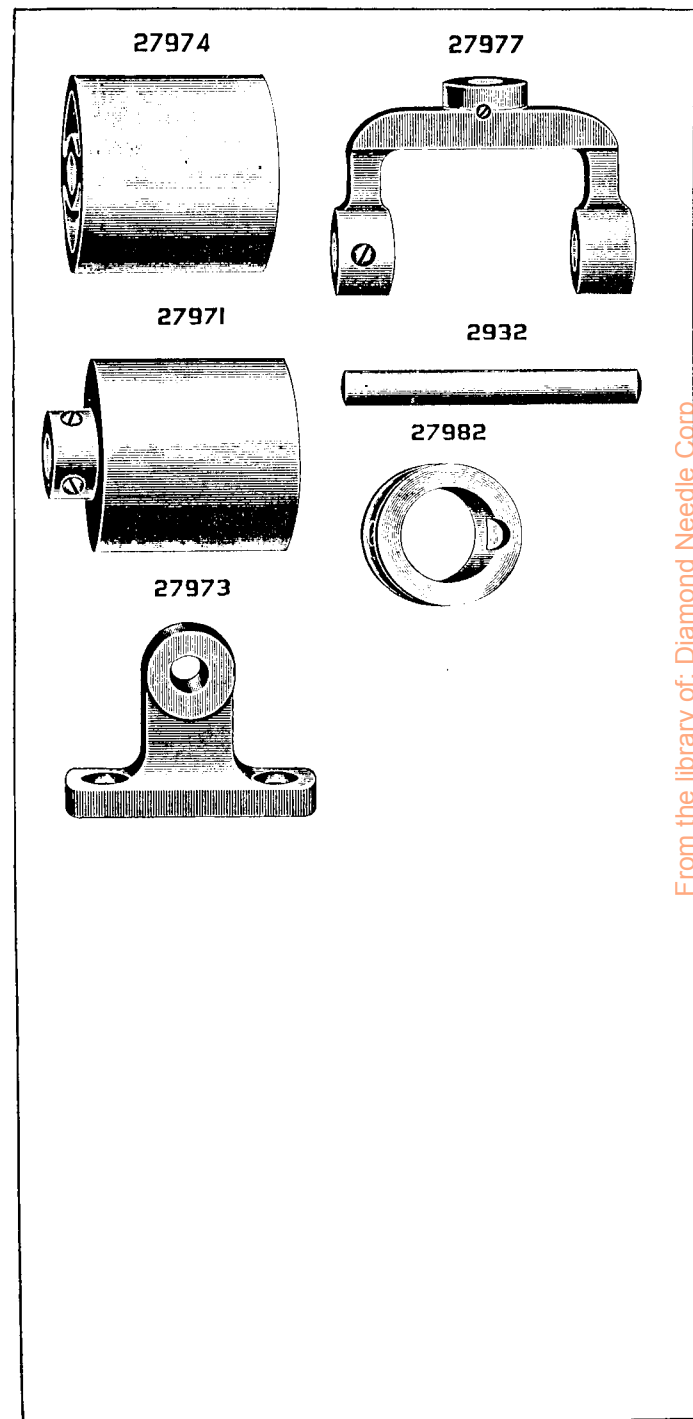


PLATE 2831—FULL SIZE

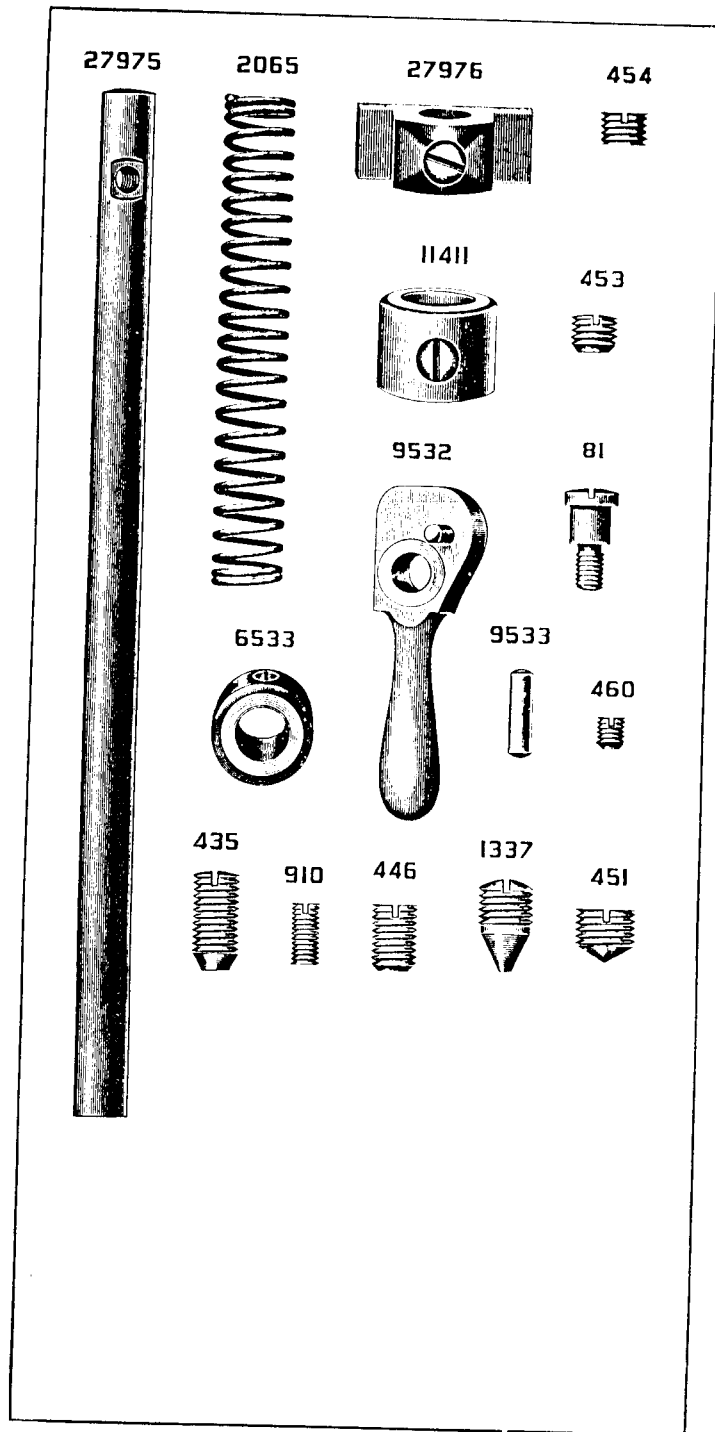
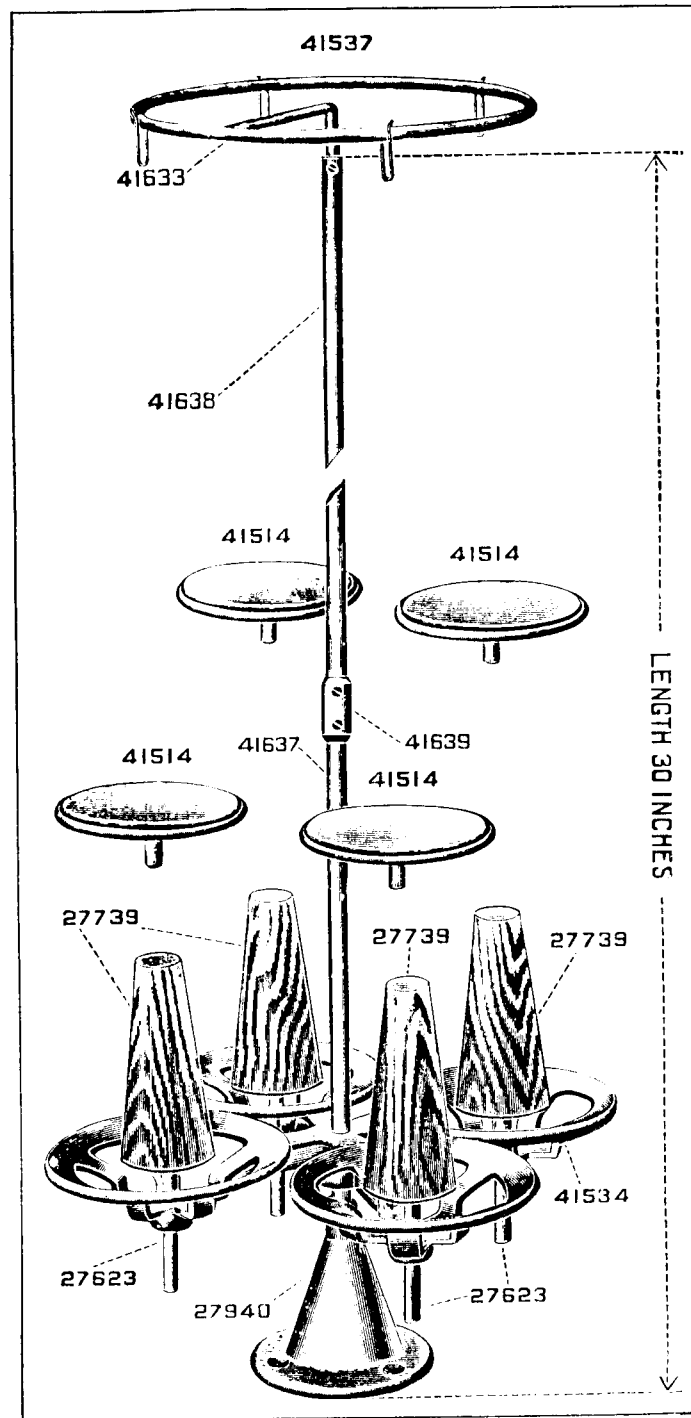


PLATE 2838—ONE-FOURTH SIZE

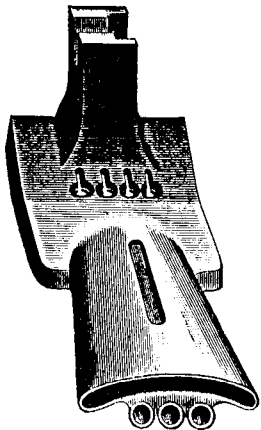


From the library of: Diamond Needle Corp

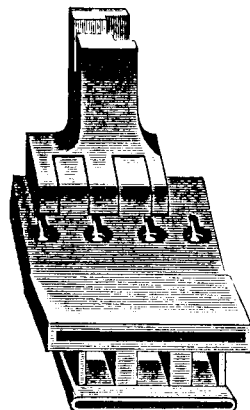


PLATE 3031—FULL SIZE

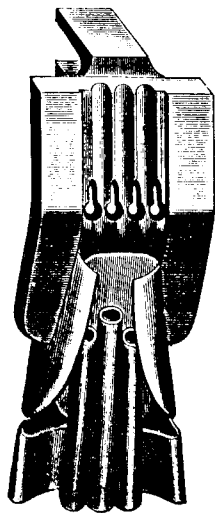
31081



31082



31081



31082

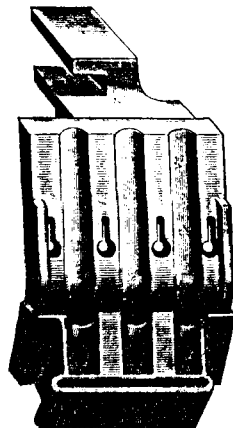
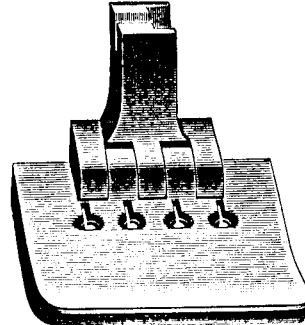
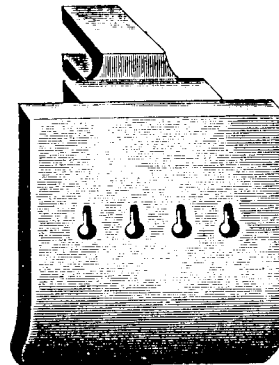


PLATE 3032—FULL SIZE

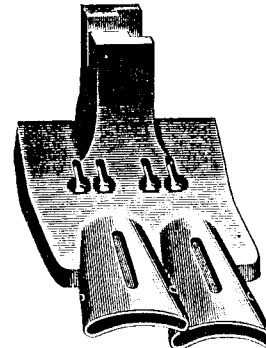
31083



31083



31084



31084

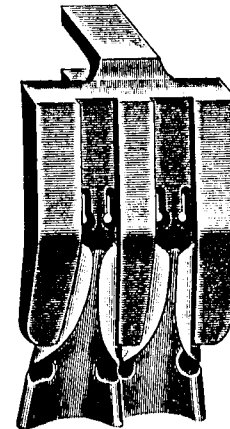
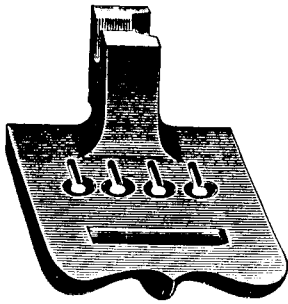
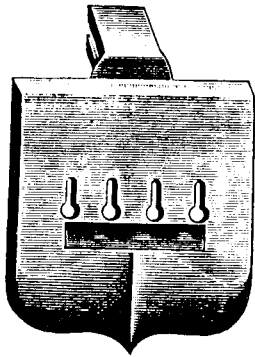


PLATE 3033—FULL SIZE

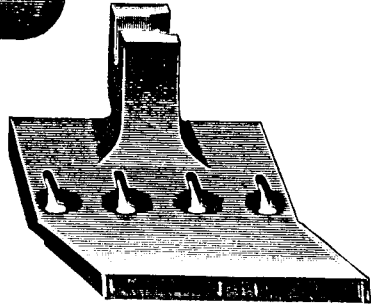
31085



31085



31086



31086

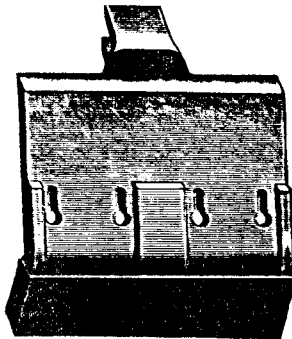
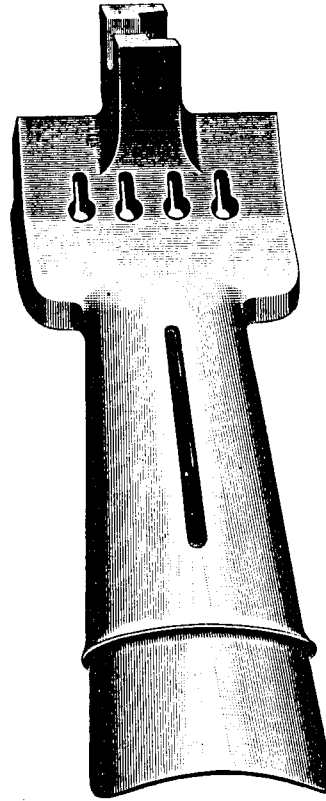
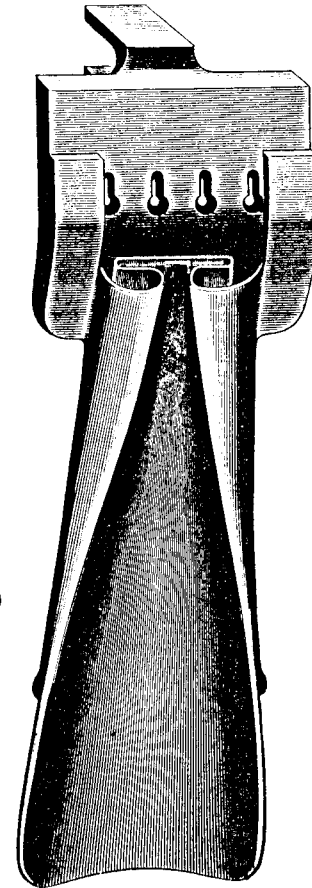


PLATE 3091—FULL SIZE

31088



31088



From the library of: Diamond Needle Corp

PLATE 3092 - FULL SIZE



PLATE 4627 - FULL SIZE

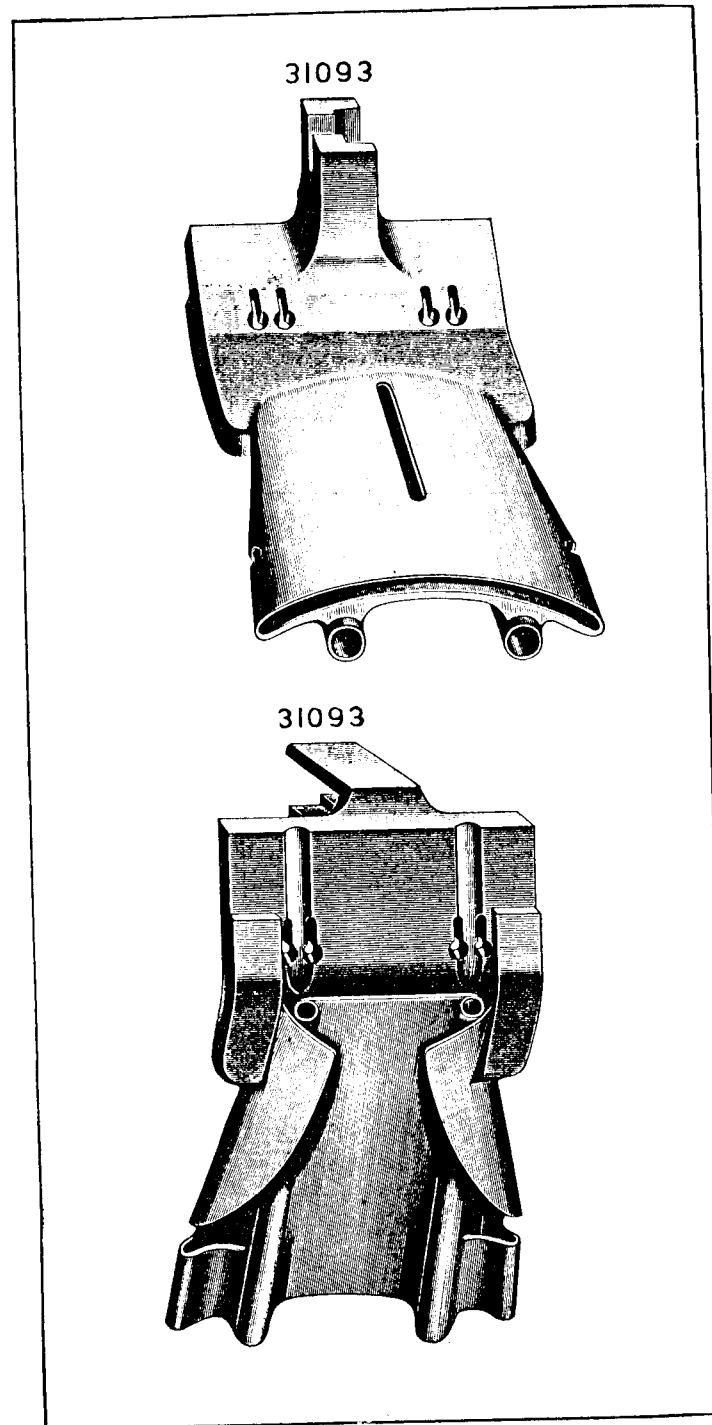
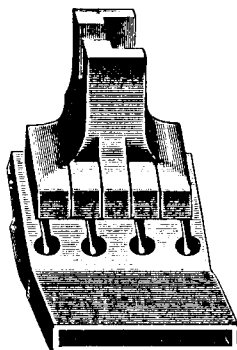
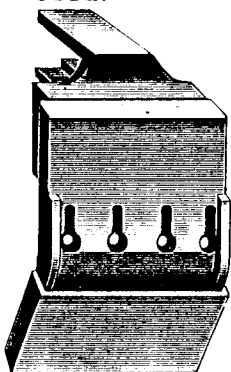


PLATE 4655—FULL SIZE

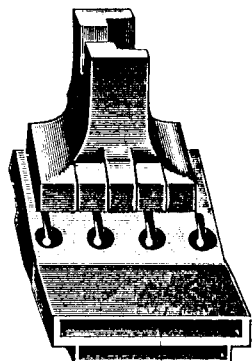
30327



30327



30330



30330

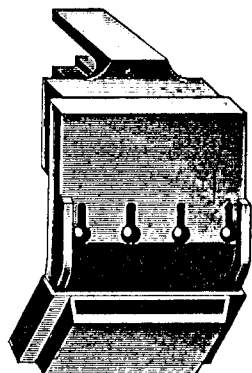
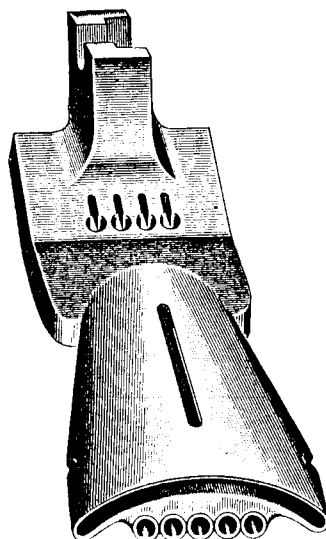
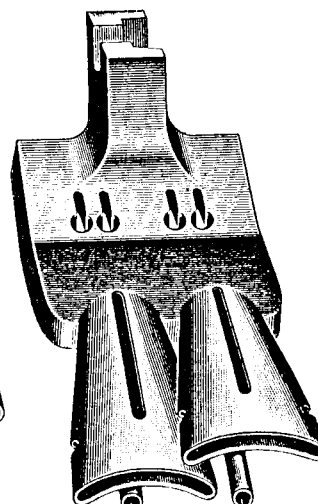


PLATE 4681—FULL SIZE

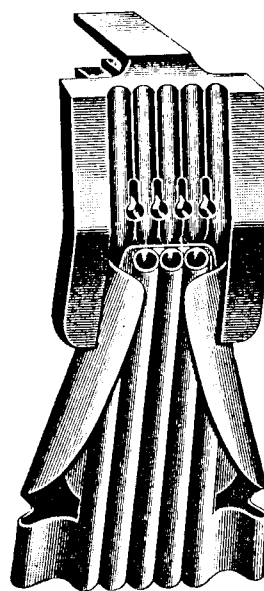
30338



30340



30338



30340

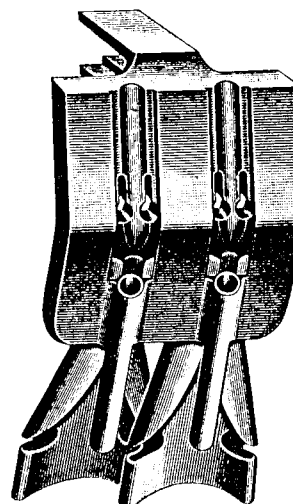
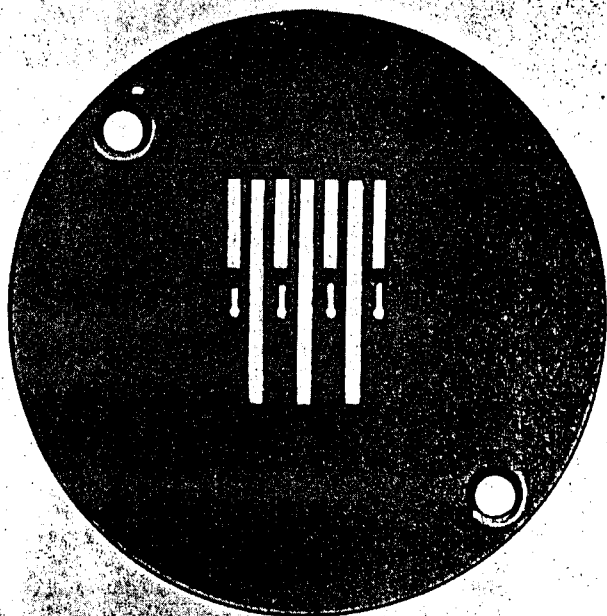


PLATE 5387—FULL SIZE

48102

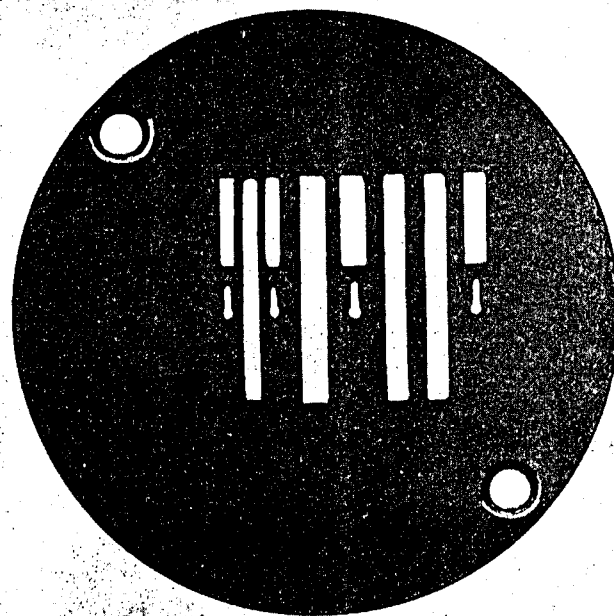


48082



PLATE 5388—FULL SIZE

48103



48083

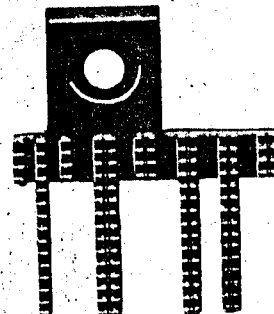
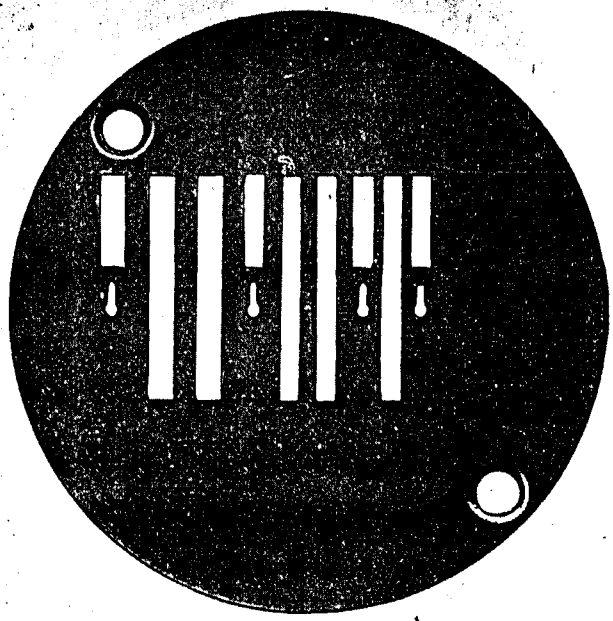


PLATE 5389—FULL SIZE

48104



48084

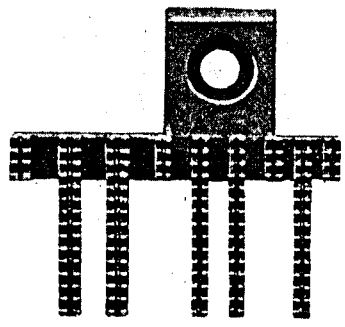
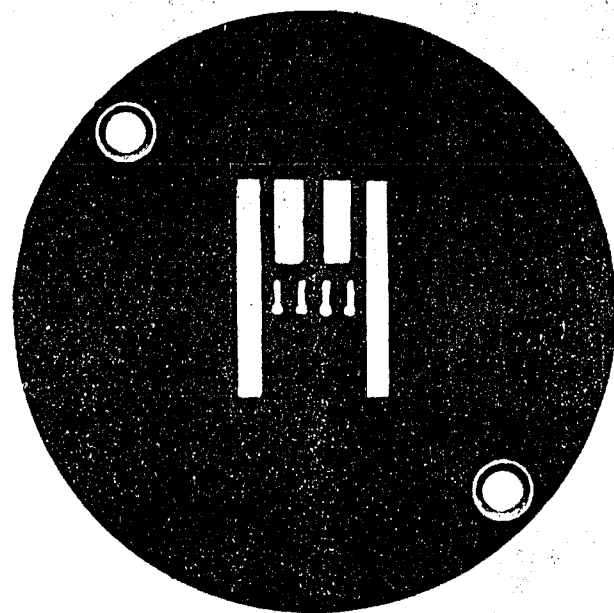


PLATE 5390—FULL SIZE

48105



48085

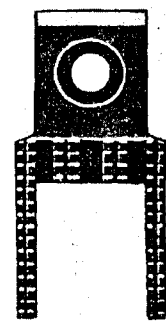
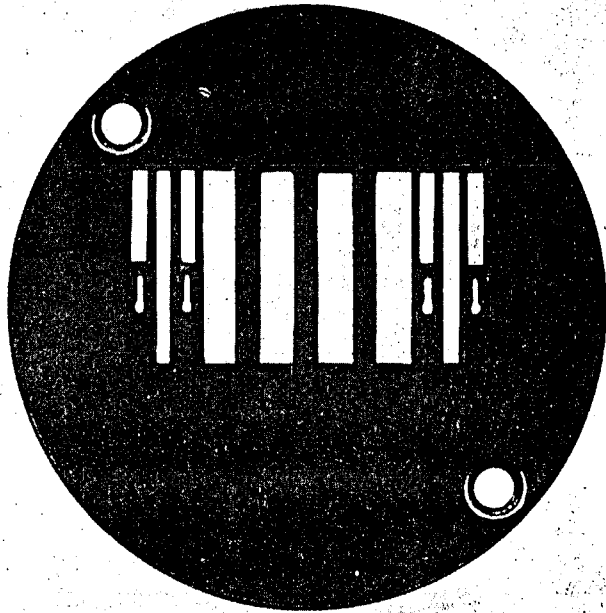


PLATE 5391—FULL SIZE

48106



48086

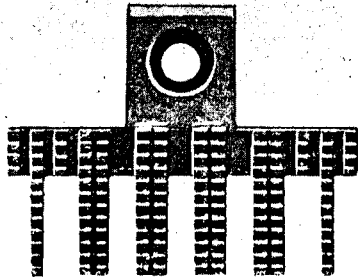
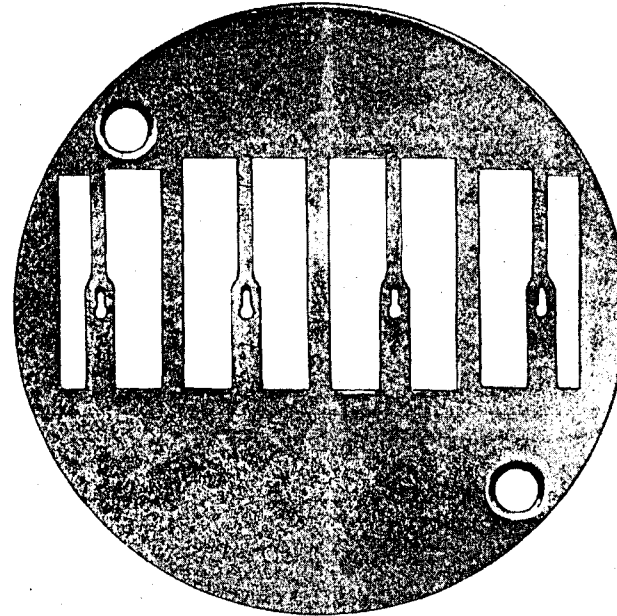


PLATE 5392—FULL SIZE

48107



48087

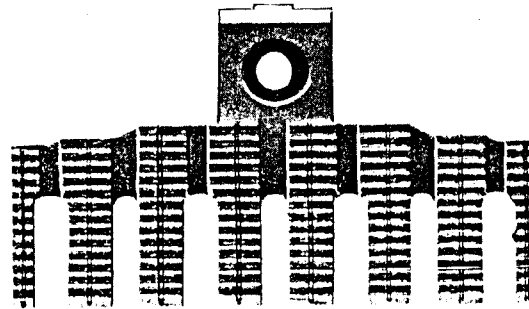
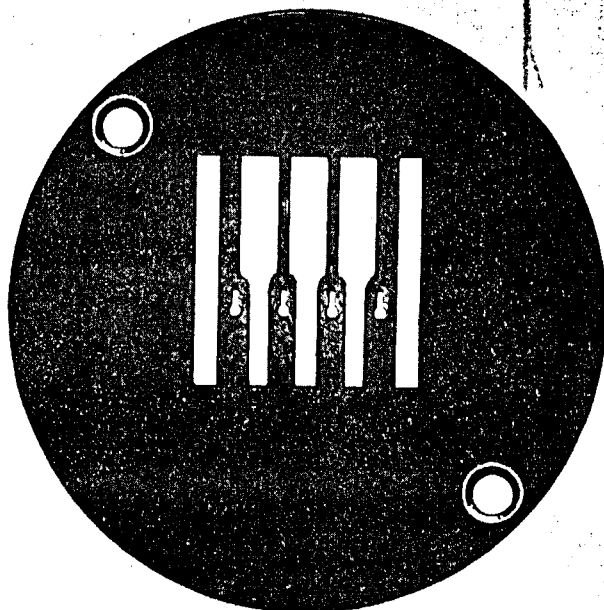


PLATE 5393—FULL SIZE

48108



48088

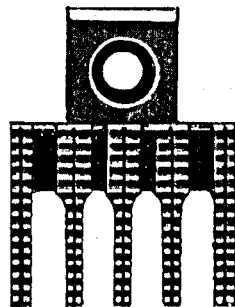
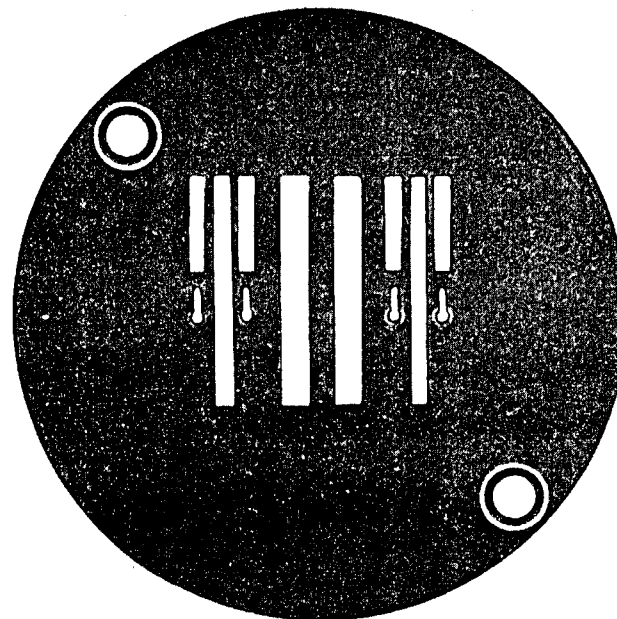


PLATE 5394—FULL SIZE

48109



48089

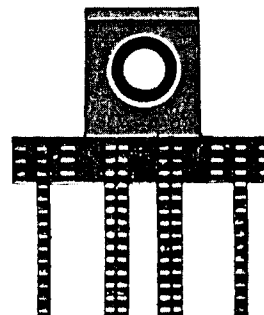
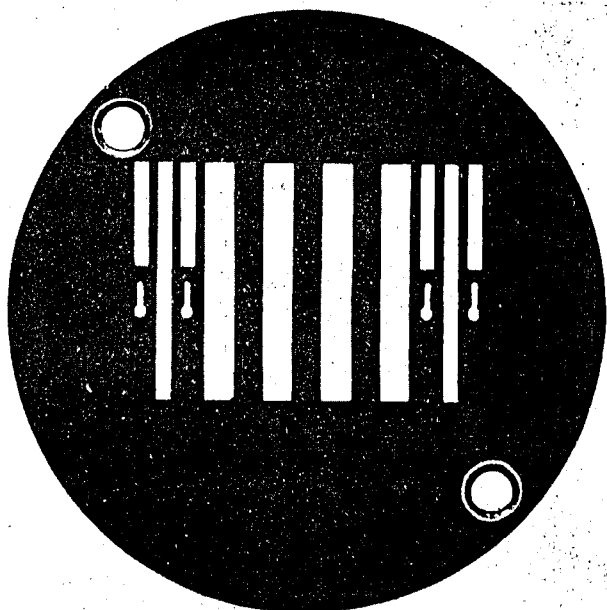




PLATE 5395—FULL SIZE

48110



48090

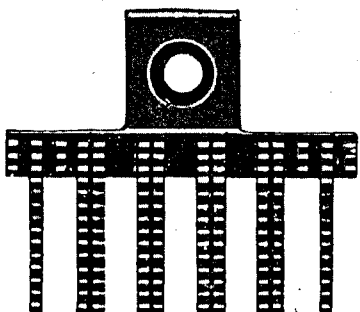
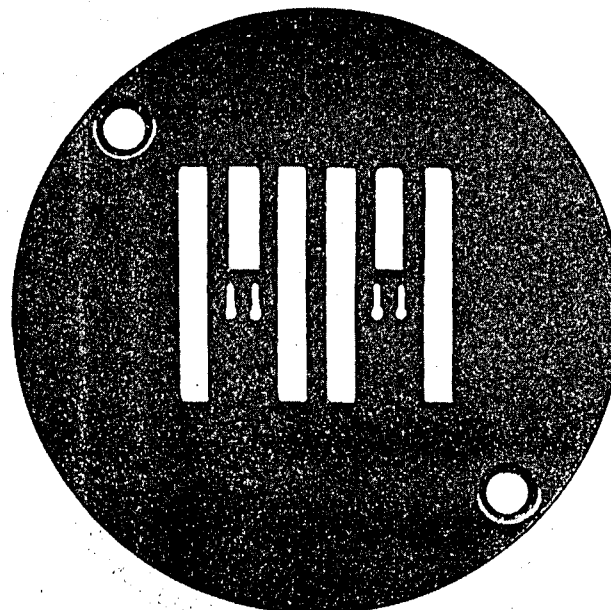


PLATE 5396—FULL SIZE

48111



48091

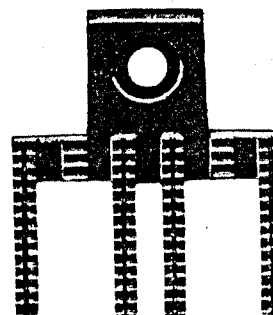
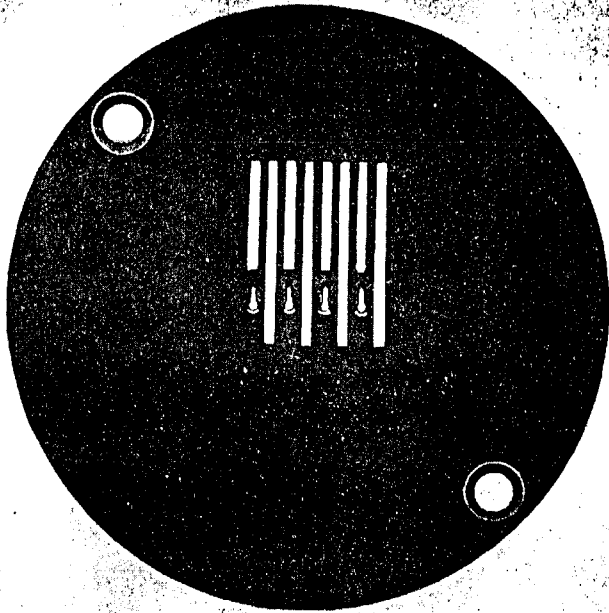


PLATE 5397—FULL SIZE

48497



48462

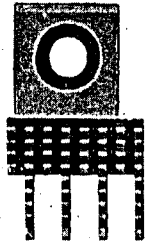
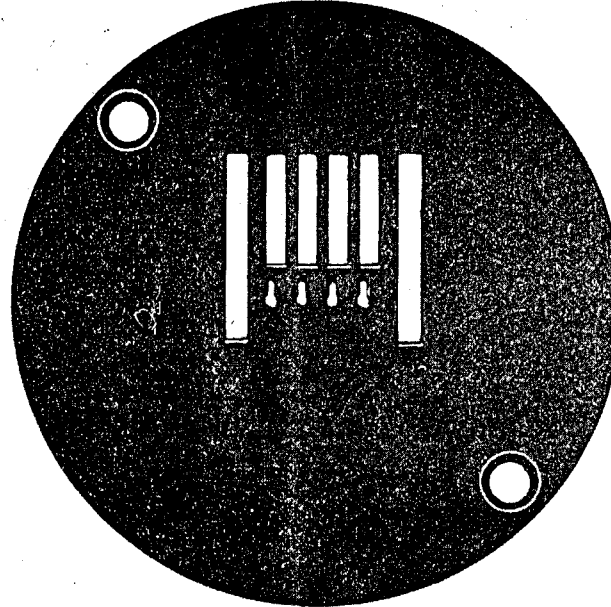


PLATE 5398—FULL SIZE

48498



48463

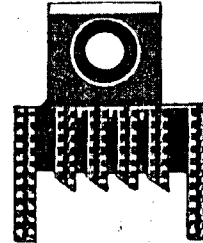
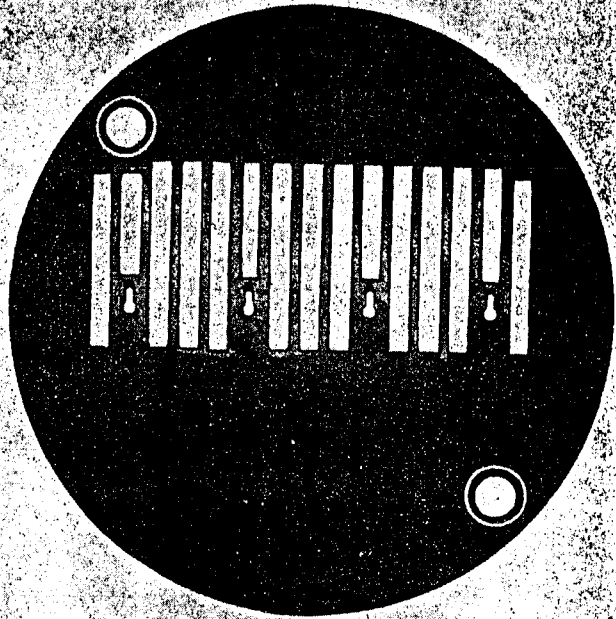


PLATE 5399—FULL SIZE

48499



48464

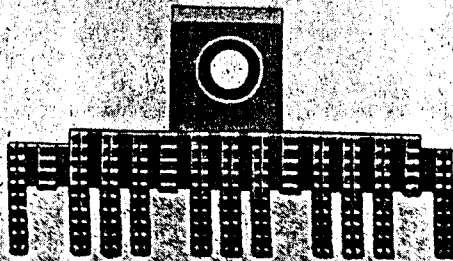
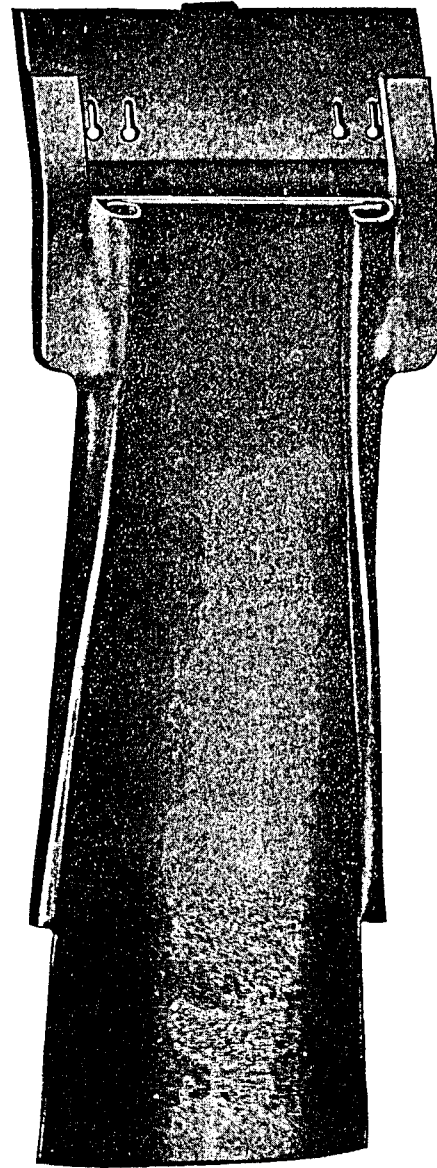


PLATE 5445—FULL SIZE

31098



From the library of: Diamond Needle Corp

PLATE 5483—FULL SIZE

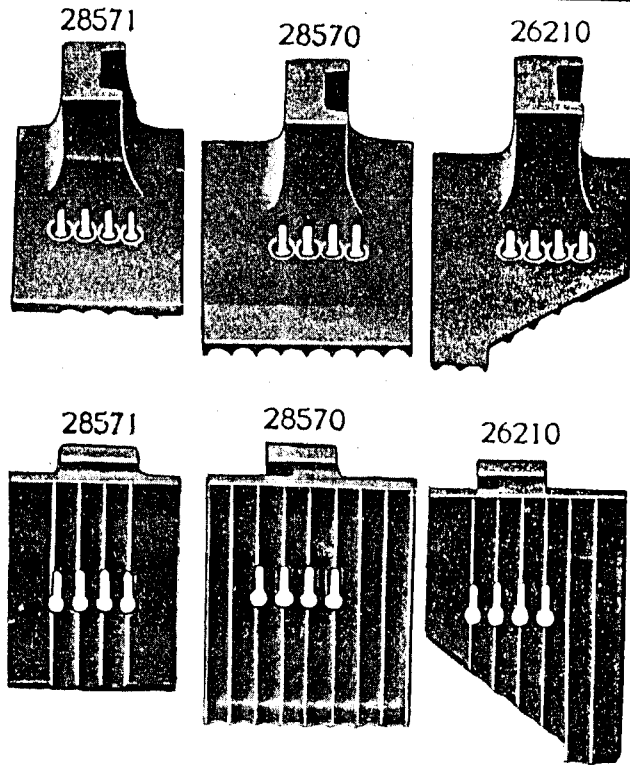


PLATE 5484—FULL SIZE

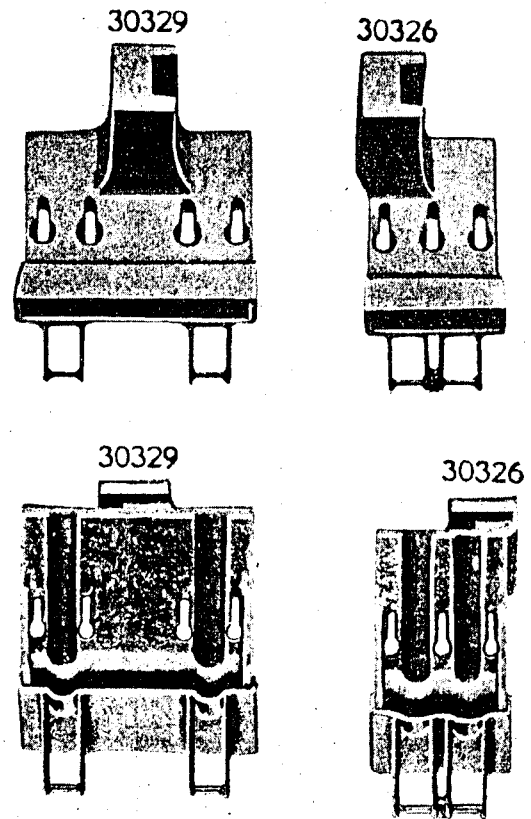
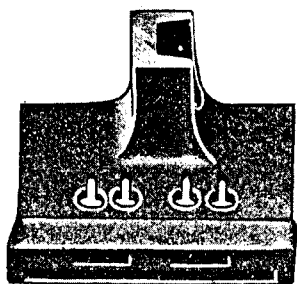
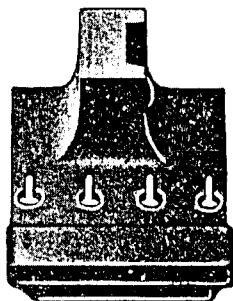


PLATE 5485—FULL SIZE

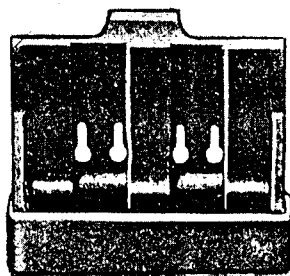
31099



30328



31099



30328

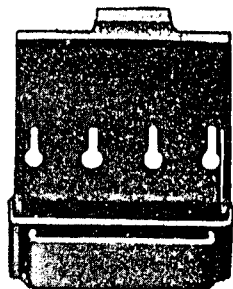
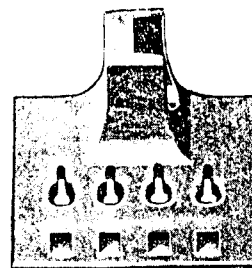
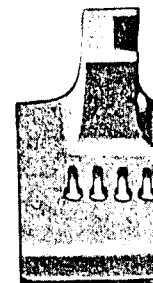


PLATE 5486—FULL SIZE

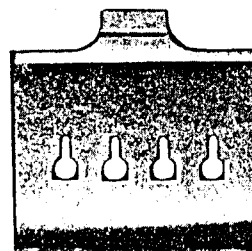
30331



31097



30331

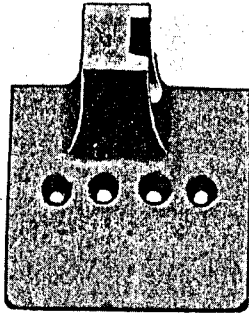


31097



PLATE 5487—FULL SIZE

30332



30332

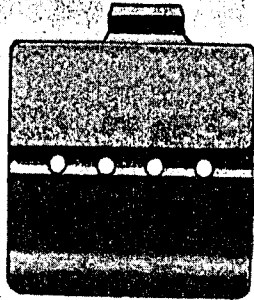
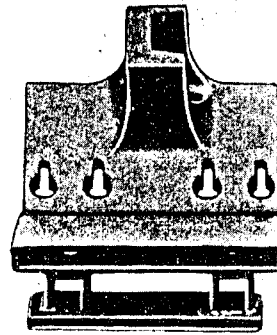
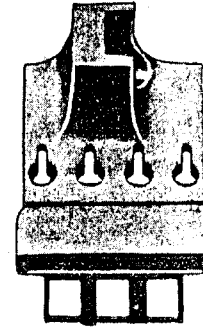


PLATE 5488—FULL SIZE

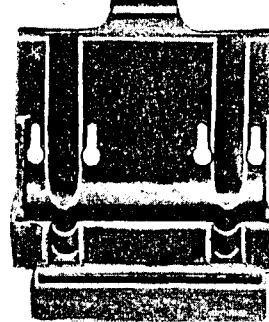
30333



30336



30333



30336

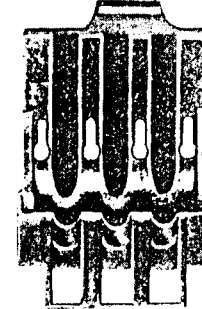
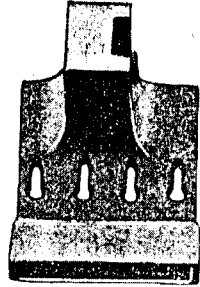


PLATE 5489—FULL SIZE

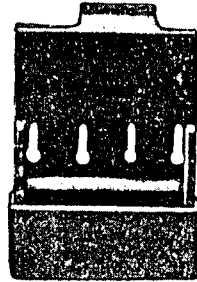
30337



30334



30337

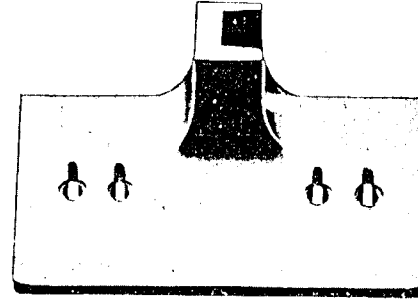


30334



PLATE 5490—FULL SIZE

30335



30335

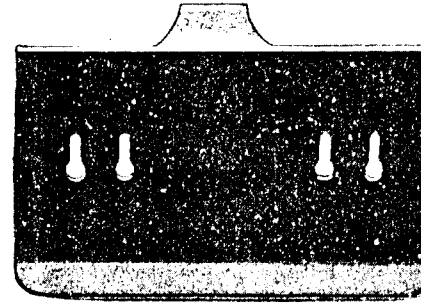


PLATE 5491—FULL SIZE

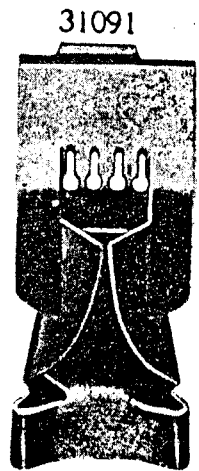
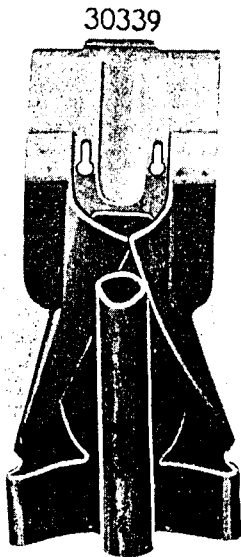
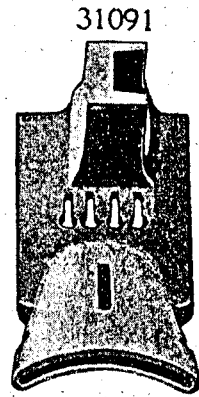
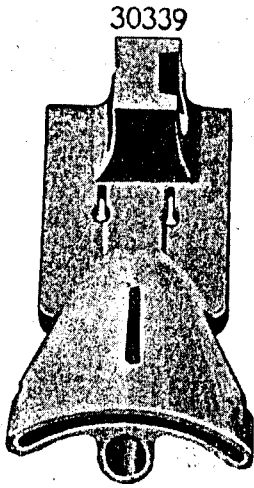


PLATE 5492—FULL SIZE

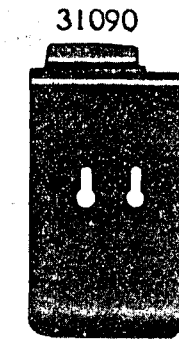
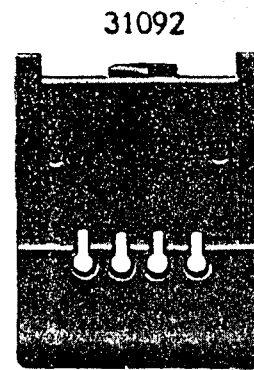
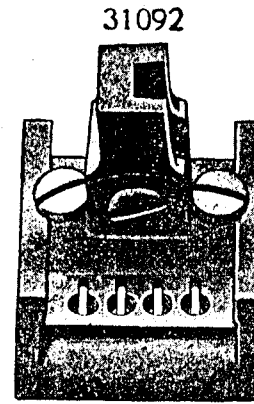
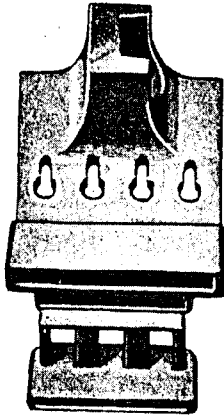


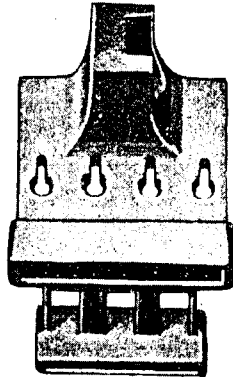


PLATE 5493—FULL SIZE

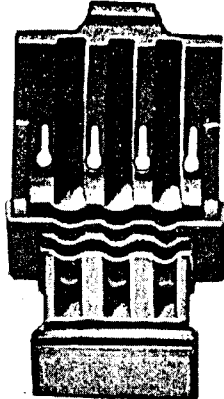
31095



31094



31095



31094

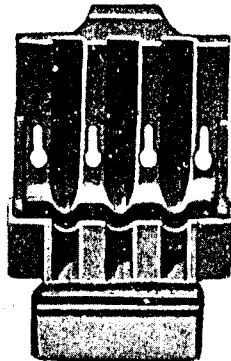
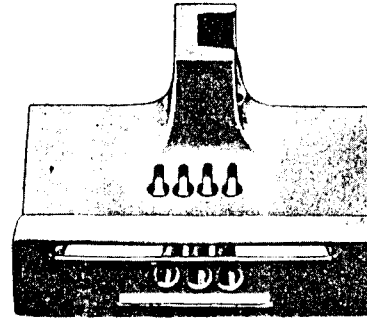
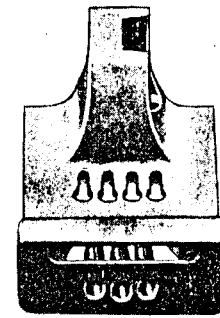


PLATE 5494—FULL SIZE

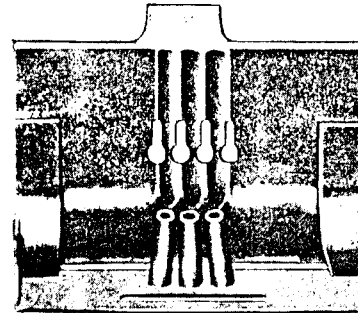
31101



31096



31101



31096

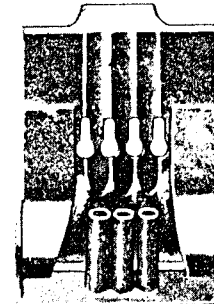
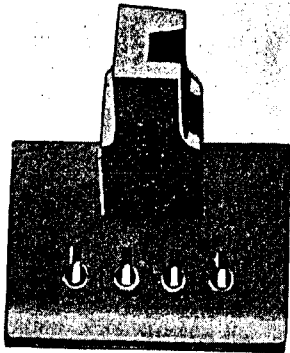


PLATE 5495—FULL SIZE

31100



31100

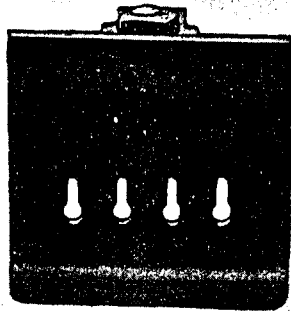
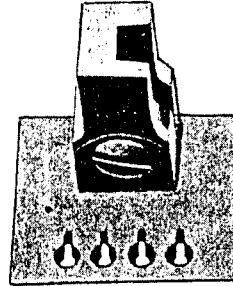


PLATE 5496—FULL SIZE

48477



48477

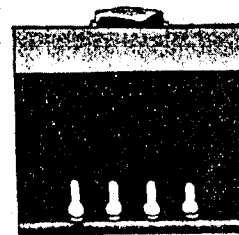


PLATE 7440—ONE-HALF SIZE

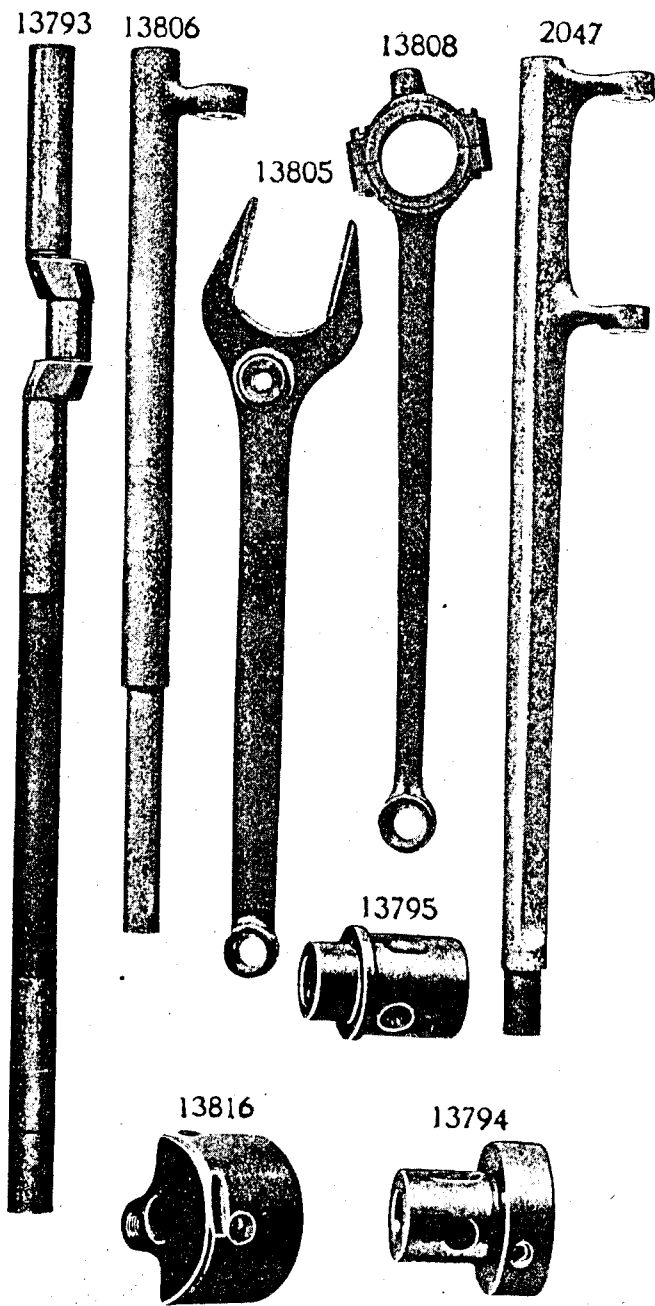
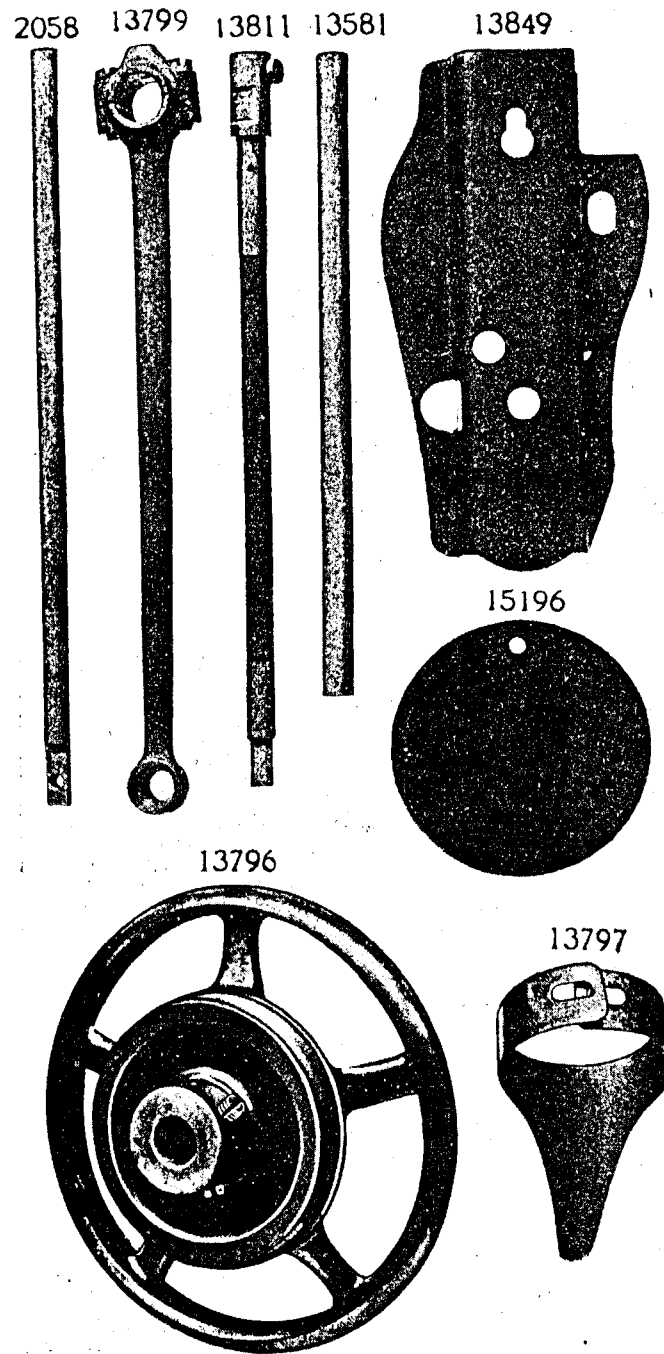


PLATE 7441—ONE-HALF SIZE



From the library of: Diamond Needle Corp

PLATE 7442—FULL SIZE

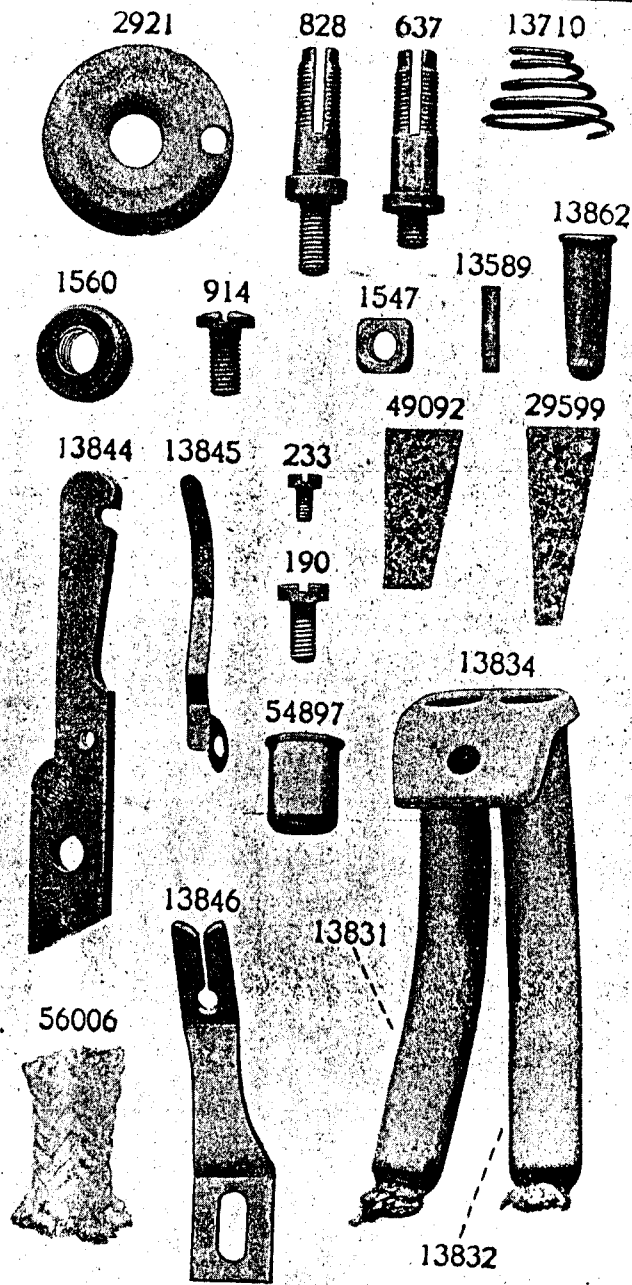


PLATE 7443—FULL SIZE

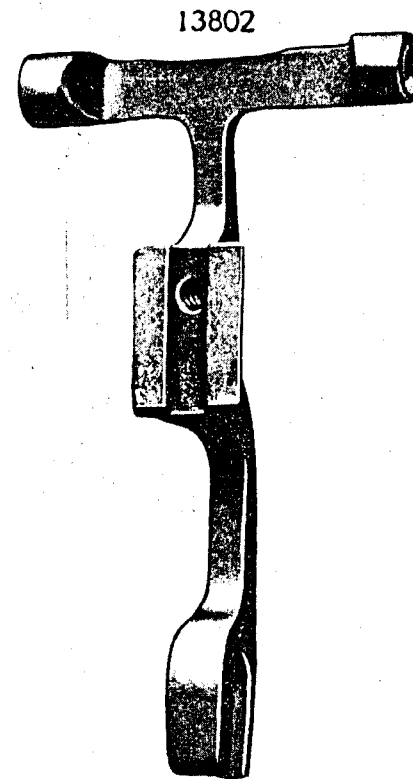


PLATE 7444—FULL SIZE

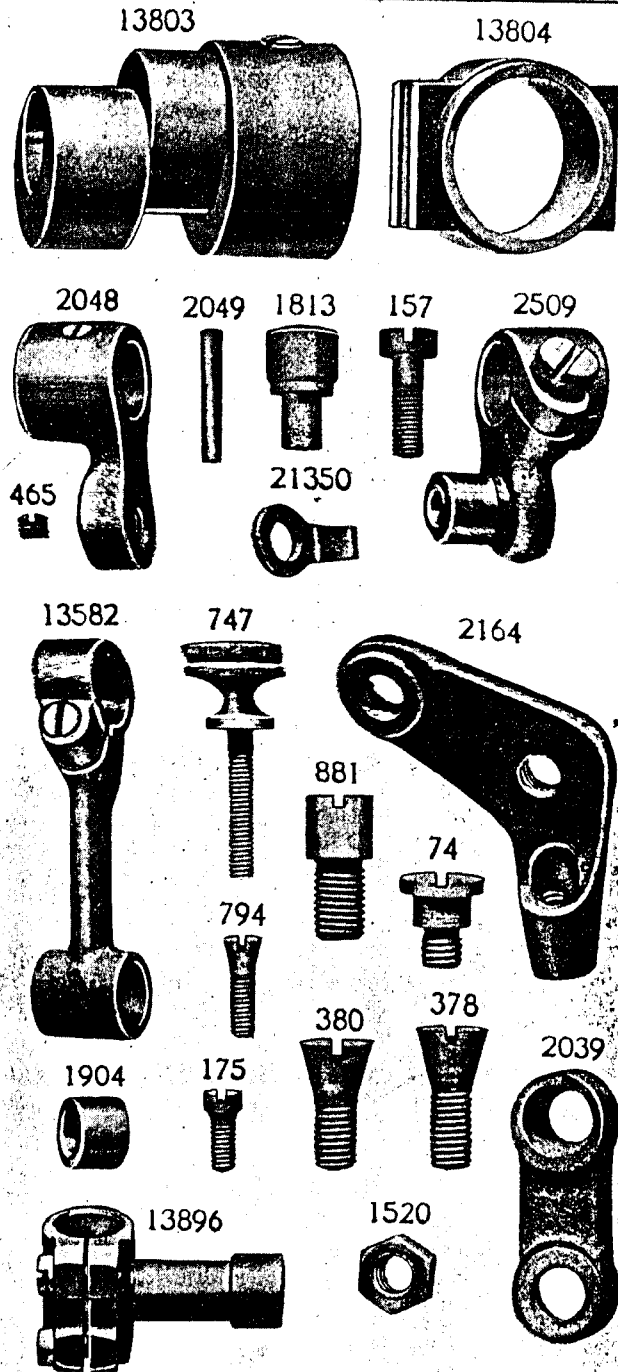
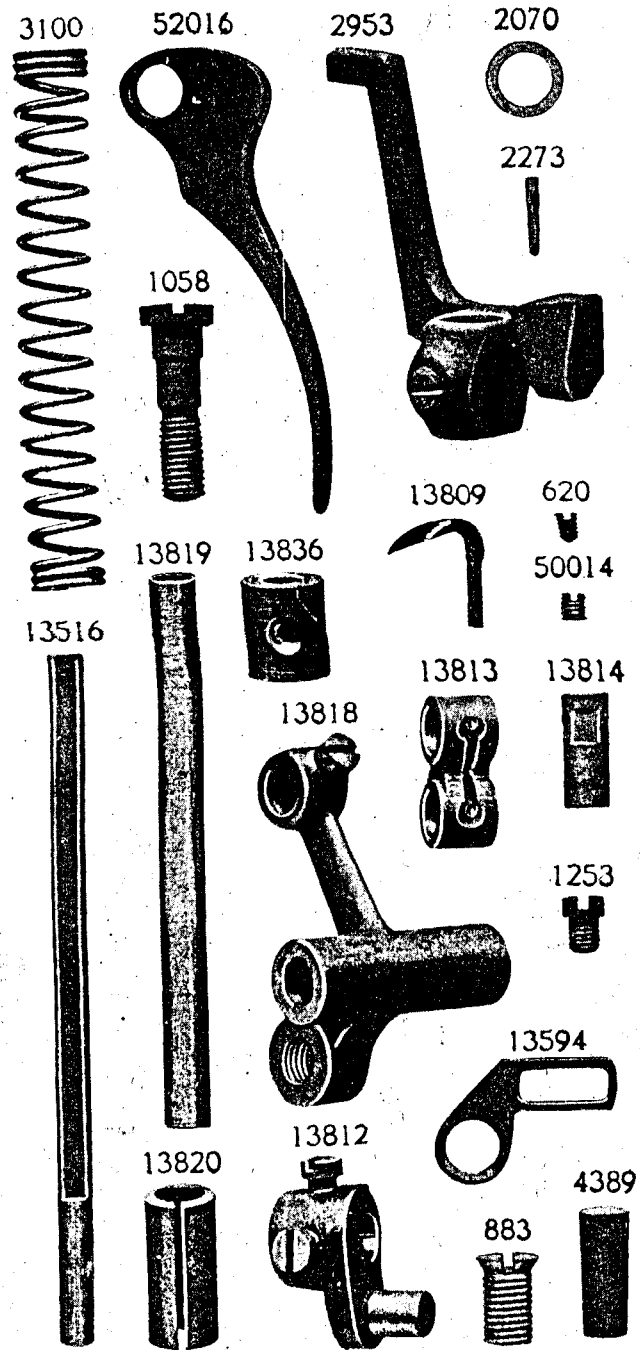


PLATE 7445—FULL SIZE



From the library of: Diamond/Needle Corp

PLATE 7446—FULL SIZE

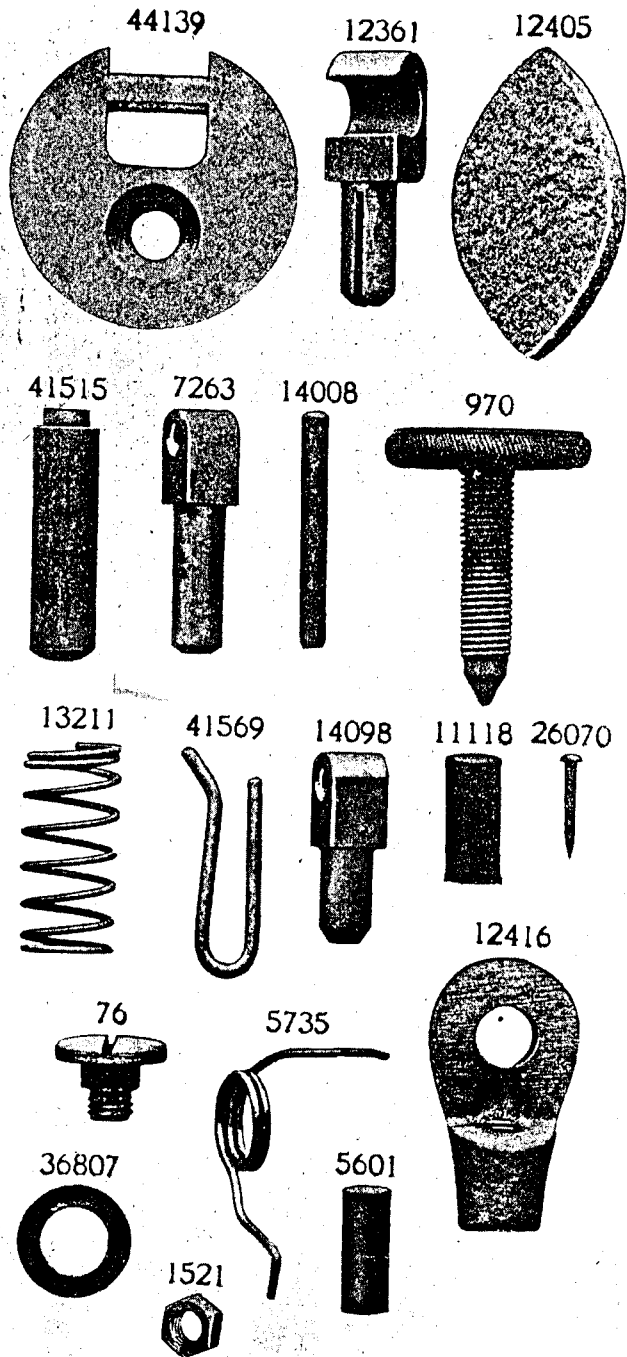
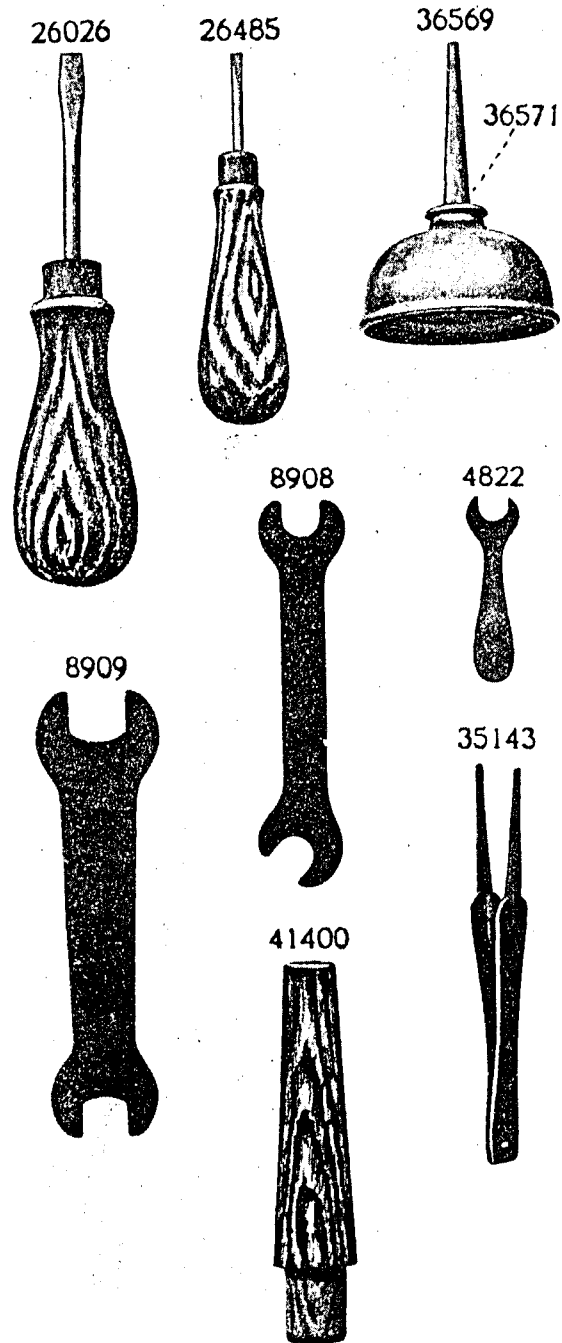


PLATE 7447—ONE-HALF SIZE



From the library of: Diamond Needle Corp

PLATE 7448—ONE-HALF SIZE

13588



13587



5598



5596



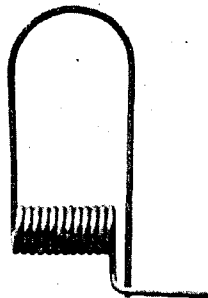
5599



4879



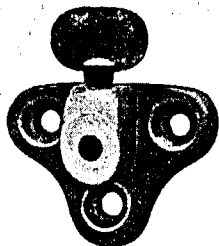
4883



4882



26064



26325

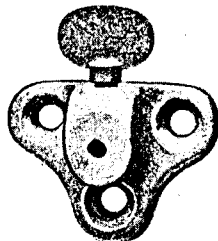
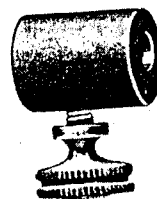


PLATE 7449—FULL SIZE

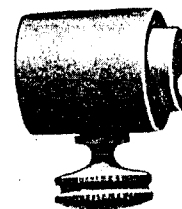
55



35925



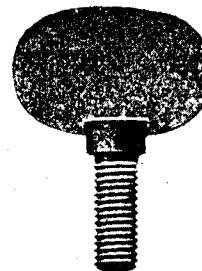
26073



284



736



25790



PLATE 7450—FULL SIZE

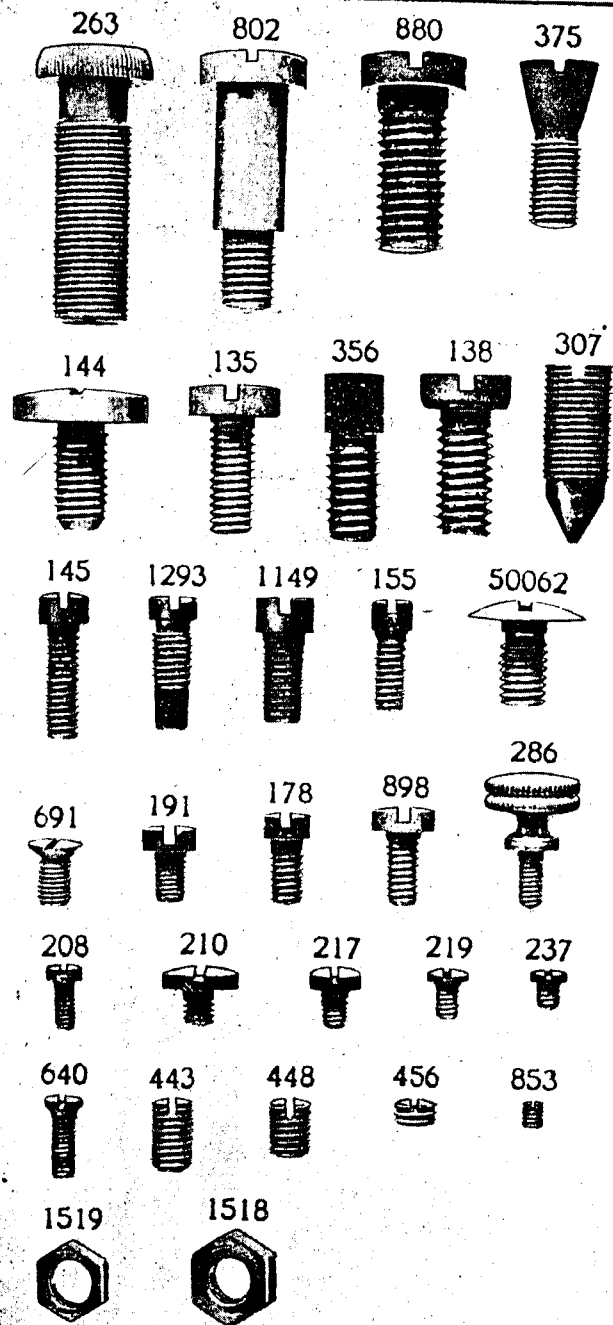
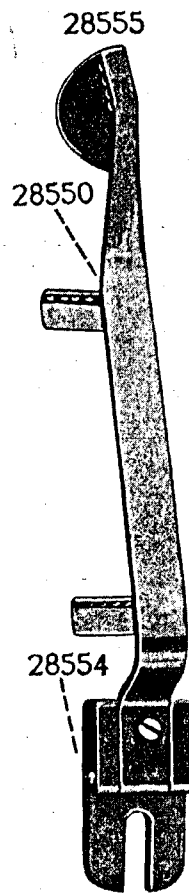


PLATE 7453—ONE-HALF SIZE



From the library of: Diamond Needle Corp



PLATE 7456—ONE-HALF SIZE

---

13851

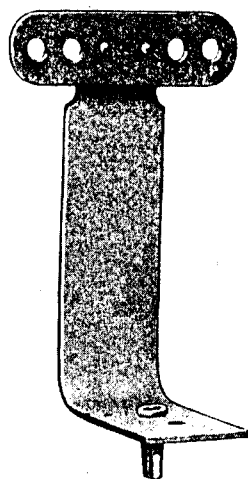


PLATE 7457—FULL SIZE

---

13854

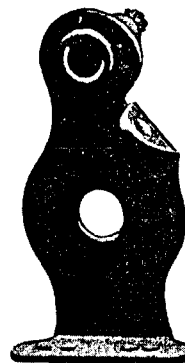
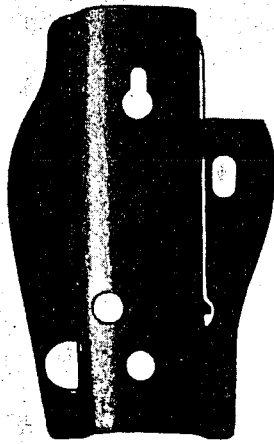


PLATE 7458—ONE-HALF SIZE

13801

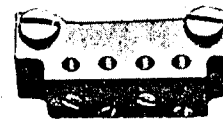


13835

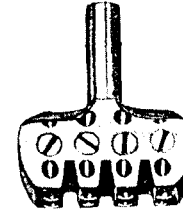


PLATE 7459—FULL SIZE

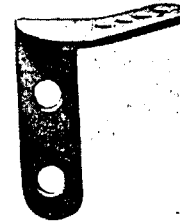
13864



13863



13852



13558

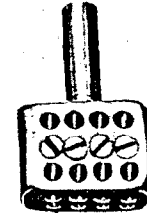


PLATE 7468—ONE-FOURTH SIZE

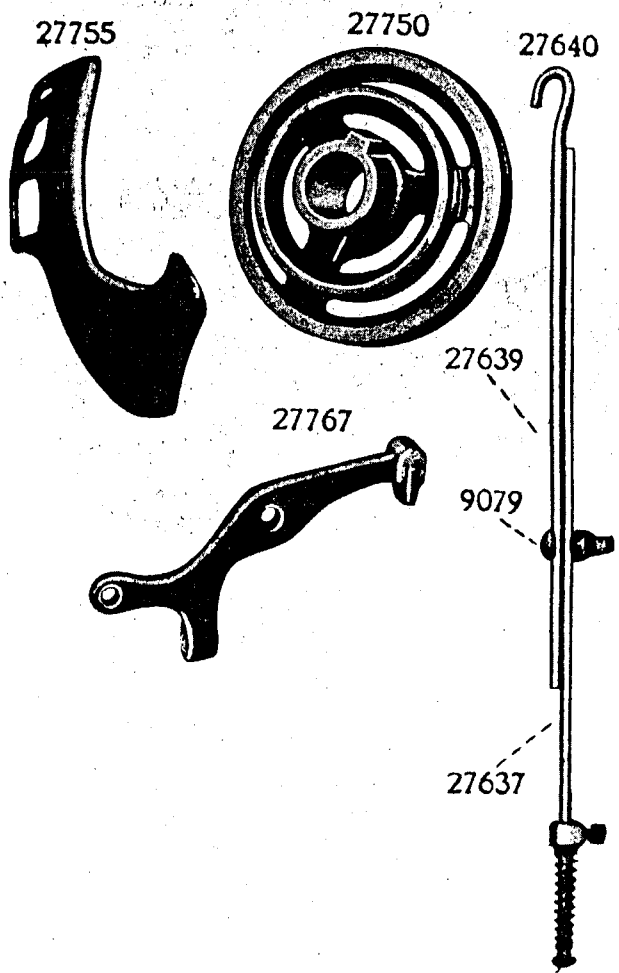


PLATE 7470—ONE-HALF SIZE

13887

